

THE FORCE OF OPTICS™

2014



TACTICAL
OPTICS

VORTEX

RIFLESCOPES | RED DOTS | BINOCULARS | RANGEFINDERS | MONOCULARS | SPOTTING SCOPES



Riflescopes p. 4-11 | Red Dots p. 12-15 | Binoculars p. 20-24 | Rangefinders p. 25 | Monoculars p. 26-27 | Spotting Scopes p. 28-29

THE FORCE OF OPTICS

2014



TACTICAL
OPTICS

VORTEX®

PRECISION AND PERFORMANCE

ARE SO ON THE SAME PAGE HERE.

ALL THE PATENTED FEATURES AND PRECISE ENGINEERING COME INTO FOCUS IN THAT NANO SECOND BETWEEN TARGET ACQUIRED AND MISSION ACCOMPLISHED. BUILT FROM THE GROUND UP TO MEET THE EXACTING NEEDS OF TACTICAL SHOOTERS, WE'VE DIALED IN ALL THE PERFORMANCE FEATURES YOU COULD WANT INTO A LINE OF OPTICS YOU CAN BET YOUR LIFE ON. MOSTLY, BECAUSE IN MANY CASES, OUR CUSTOMERS DO.

TACTICAL OPTICS | THE FORCE OF OPTICS



RAZOR® HD GEN II

3-18x50 / 4.5-27x56 RIFLESCOPES

MADE TO EXACTING STANDARDS –
as in exactly what you need to bring it.

COMPLETELY
NEW
FOR 2014

Our all-new Razor® HD Gen II riflescopes are designed and engineered for dialing precision long-range shots in extreme environments. Available in 4.5-27x56 and 3-18x50 configurations, these scopes will have serious precision shooters saying “finally.”

HERE'S WHY:

The new L-Tec™ Turret System boasts an integrated pop-up-and-down locking mechanism that prevents accidental elevation adjustment – and turret-marking references that provide easily read elevation and windage adjustment graduations. An infinite number of setting positions allow zero to be set between clicks for optimal precision and accuracy. Zero stop feature provides positive zero returns after dialing temporary elevation correction. And with its visual, as well as tactile, turret rotation indicator, shooters can keep track of turns with ease.

A lockable illumination dial is integrated into the side focus adjustment knob for easy access and a streamlined profile. It features eleven intensity levels of illumination with off positions between each setting.

The new Razor HD Gen II Riflescopes deliver a 6X zoom range and stunning image quality. The APO (apochromatic) objective lens system uses index-matched lenses to correct color across the entire visual spectrum, and HD (High Density) premium extra-low dispersion glass delivers the ultimate in resolution and color fidelity – resulting in High Definition images. New XRPlus™ premium fully multicoated lenses dramatically increase light transmission for superior brightness in low-light conditions, while ArmorTek® protects exterior lenses from scratches, oil and dirt.

FEATURES
RAZOR HD GEN II



APO (apochromatic) objective lens system uses index-matched lenses to correct color across the entire visual spectrum.

HD (High Density) premium extra-low dispersion glass delivers the ultimate in resolution and color fidelity, resulting in High Definition images.

XRPlus™ premium fully multi-coated lenses deliver the highest level of light transmission for maximum brightness.

Plasma Tech™ application process provides unparalleled coating durability and performance.

ArmorTek® protects exterior lenses from scratches, oil and dirt.

Argon gas purging with o-ring seals guarantees superior fogproof and waterproof performance.

Shockproof construction withstands recoil and impact.

One-piece, aircraft-grade aluminum alloy construction.

34mm diameter main tube with Stealth Shadow finish.

First focal plane illuminated glass-etched reticle.

Matching turrets and reticles in mrad or MOA .

Fast-focus eyepiece.

L-Tec™ turrets with locking mechanism provide fast, accurate, easily read elevation and windage adjustments. Patent pending.

6x zoom range.



4.5-27 X 56
34MM TUBE

3-18 X 50
34MM TUBE

Patented Design

RAZOR HD GEN II RIFLESCOPES

MAGNIFICATION x OBJECTIVE LENS	RETICLE OPTIONS	WEIGHT	LENGTH	FIELD OF VIEW AT 100 YARDS	EYE RELIEF (MAX POWER)	TURRET STYLE
* 4.5-27 x 56 FFP	EBR-1C MRAD EBR-2C MOA EBR-2C MRAD	48.5 oz	14.4"	25.3 - 4.4'	3.7"	L-Tec
* 3-18 x 50 FFP	EBR-2C MOA EBR-2C MRAD	46.5 oz	14.4"	37.8 - 6.25'	3.7"	L-Tec

34mm Tube



* New Model for 2014 Dual Use: Shooting Tactical / Hunting

US Patent 7,958,665



PRECISION IS NOT AN OPTION. IT'S A REQUIREMENT.

MOA or mrad turrets with matching first focal plane glass-etched reticles ensure subtensions remain constant throughout the zoom range. Each Razor HD Gen II riflescope is machined from a solid block of aircraft-grade aluminum with a 34mm tube diameter to maximize internal adjustment. Protected by a hard-anodized Stealth Shadow finish, O-ring sealed to prevent moisture, dust and debris from penetrating and argon gas purged to prevent internal fogging over a wide range of temperatures.

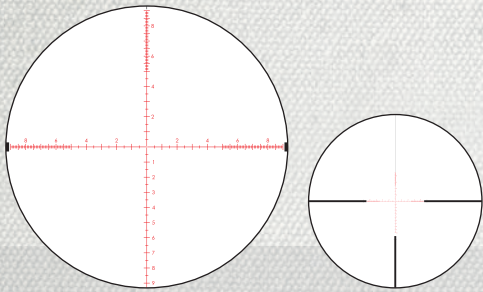

RAZOR HD GEN II EBR-1C RETICLE

New for 2014, the EBR-1C is a hashmarked ranging reticle using MRAD-based subtension lines for ranging, holdover and windage corrections.

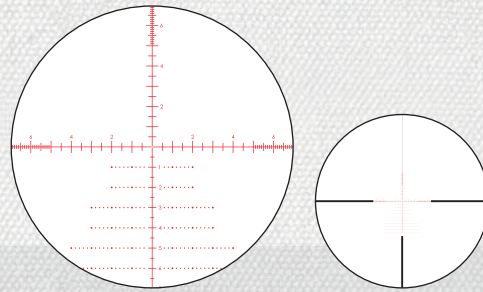

RAZOR HD GEN II EBR-2C RETICLE

New for 2014, the EBR-2C is a hashmarked ranging reticle using MOA or MRAD-based subtension lines for ranging, holdover and windage corrections. Includes windage reference dots on drop lines.

Close-up views of reticle shown here. See pages 30-31 for more detailed information on available reticles.



◀ **L-TEC™ TURRETS:**

Integrated locking mechanism prevents accidental adjustments. Turrets provide fast, accurate, easily read elevation and windage adjustments. Using rugged internal components, the L-TEC zero stop assists reliable return to zero. Patent pending.

3.7 INCH EYE RELIEF:

The Razor HD provides generous and consistent eye relief at all magnifications for faster target acquisition when shooting in a wide variety of positions and situations.

LARGE WINDAGE AND ELEVATION ADJUSTMENT RANGE:

The Razor HD Gen IIs offer a wide adjustment range for both windage and elevation allowing easy accommodation for bullet drop at extreme ranges.

4.5–27x56: 114 MOA / 33 MRAD
3–18x50: 117 MOA / 34 MRAD



◀ **LOCKING SIDE ILLUMINATION:**

Integrated on the side focus for easy access. Locks illumination at preferred setting and features eleven intensity levels of illumination with off positions between each setting.



◀ **EXTERNAL ROTATION INDICATOR:**

Designed to provide quick visual and tactile reference of the elevation turret's rotational position.

MATCHED TURRETS AND RETICLES:

The subtensions on MOA and mrad version reticles match the subtension markings on the turrets to make range calculation and shooting adjustments faster and more accurate.

PARALLAX ADJUSTMENT:

Located on the left side of the turret housing, the parallax setting can be observed and adjusted from the shooting position.

HARD ANODIZED FINISH:

The hard-coat anodized finish features a low-glare matte surface in Vortex's proprietary Stealth Shadow color. The hard-coat anodization resists scratching and abrasion while maintaining a dull, durable, glare-free finish.

RAZOR® HD GEN II

1-6x24 RIFLESCOPES

1-6 X 24
30MM TUBE
Patented Design



FEATURES

RAZOR HD GEN II



APO (apochromatic) objective lens system uses index-matched lenses to correct color across the entire visual spectrum.

HD (High Density) premium extra-low dispersion glass delivers the ultimate in resolution and color fidelity, resulting in High Definition images.

XRPlus™ premium fully multi-coated lenses deliver the highest level of light transmission for maximum brightness.

Plasma Tech™ application process provides unparalleled coating durability and performance.

ArmorTek® protects exterior lenses from scratches, oil and dirt.

Argon gas purging with o-ring seals guarantees superior fogproof and waterproof performance.

Shockproof construction withstands recoil and impact.

One-piece, aircraft-grade aluminum alloy construction.

30mm diameter main tube with Stealth Shadow finish.

Matching turrets and reticles in mrad or MOA.

Fast-focus eyepiece.

6x zoom range.

NANOSECONDS WELL SPENT.

Designed specifically for the AR platform, the Razor® HD Gen II 1-6x24 is the ideal optical solution for short to medium-range tactical applications. With generous eye relief for fast target acquisition, they feature HD lens elements, an APO objective lens system and our proprietary XRPlus™ anti-reflective coatings to deliver the highest level of clarity, resolution, color accuracy, light transmission and edge-to-edge sharpness obtainable. Built like a tank on a 30mm, one-piece aircraft-grade aluminum tube, o-ring seals and argon gas purging guarantees 100% waterproof/fogproof/dustproof performance.



LOCKING SIDE ILLUMINATION

Integrated on the side focus for easy access. Locks illumination at preferred setting and features eleven intensity levels of illumination with off positions between each setting.

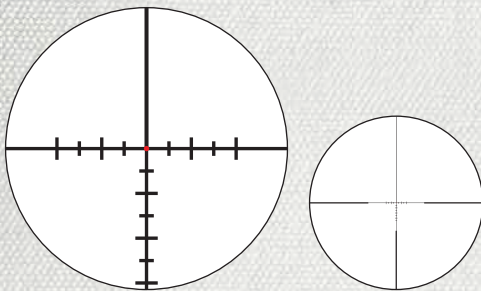

RAZOR HD GEN II VMR-2 RETICLE

New for 2014, the VMR-2 (Vortex Milling Reticle) is a hashmarked ranging reticle using MOA or MRAD-based subtension lines for ranging, holdover and windage corrections.

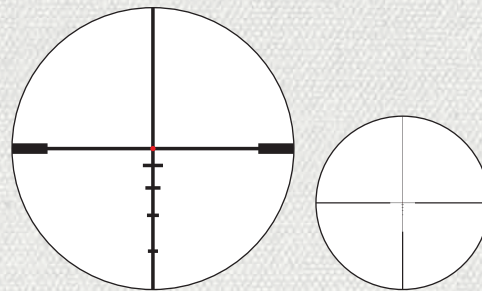

RAZOR HD GEN II JM-1 RETICLE

Designed with input from world-renowned competitive shooter, instructor and gunsmith, Jerry Miculek, the Vortex-exclusive JM-1 BDC reticle facilitates rapid, accurate shooting at distances from 0 to 600 yards. MOA-based subtension lines.

A true daylight-bright illuminated center dot gives shooters red dot sight functionality and ultimate close-quarters versatility. Illumination is accessed and activated via the locking illumination dial positioned cleanly on the left side of the turret housing.

Close-up views of reticle shown here. See page 31 for more detailed information on available reticles.

RAZOR HD GEN II RIFLESCOPES

	MAGNIFICATION x OBJECTIVE LENS	RETICLE OPTIONS	WEIGHT	LENGTH	FIELD OF VIEW AT 100 YARDS	EYE RELIEF (MAX POWER)	TURRET STYLE
30mm Tube	1-6 x 24	*VMR-2 MOA *VMR-2 MRAD JM-1 MOA	25.2 oz	10.1"	115.2 - 20.5'	4.0"	Low Capped

* New Model for 2014 Dual Use: Shooting Tactical / Hunting

US Patent 7,958,665



ADDED NEW
MODELS
FOR 2014

RIFLESCOPES



RAZOR® HD

5-20x50 RIFLESCOPES

SCOPES THAT WRITE CHECKS your rifle can cash.

A state-of-the-art, long-range performer, the Razor® HD is built on a 35mm one-piece tube and packed with more than a dozen unique performance and optical features – including Vortex's proprietary hash marked MOA and mrad ranging reticles. Simply put, the Razor HD has redefined precision scope performance in an industry where few scopes can compete.



5-20 X 50
35MM TUBE

Patented Design

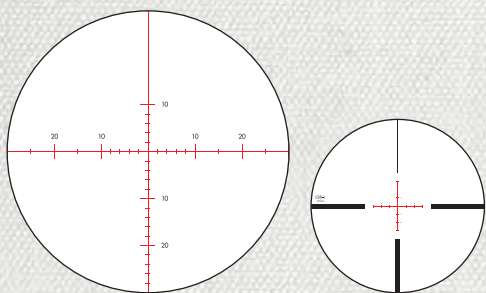

RAZOR HD EBR-1 RETICLE

Hashmarked ranging reticle using MOA-based subtension lines for ranging, holdover, and windage corrections. For MRAD-based subtension lines, choose the EBR-3 for this reticle.

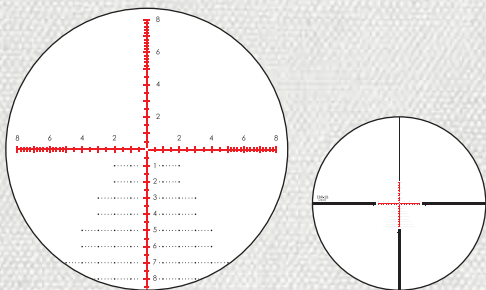

RAZOR HD EBR-2B RETICLE

Hashmarked ranging reticle using MOA or MRAD-based subtension lines for ranging, holdover and windage corrections.

Close-up views of reticle shown here. See pages 32-33 for more detailed information on available reticles.

FEATURES

RAZOR HD



HD (High Density) premium extra-low dispersion glass delivers the ultimate in resolution and color fidelity, resulting in High Definition images.

XR™ fully multi-coated lenses increase light transmission for optimal brightness.

ArmorTek® protects exterior lenses from scratches, oil and dirt.

Argon gas purging with o-ring seals guarantees superior fogproof and waterproof performance.

Shockproof construction withstands recoil and impact.

One-piece, aircraft-grade aluminum alloy construction.

35mm diameter main tube with Stealth Shadow finish.

125 MOA/36 mrad windage/elevation adjustments available.

Matching turrets and reticles in mrad or MOA.

First focal plane illuminated, glass-etched reticle.

RZR™ Zero stop prevents turret from rotating below sight-in zero.

Fast-focus eyepiece.

Exposed tactical turrets.

4x zoom range.

RAZOR HD RIFLESCOPES

MAGNIFICATION x OBJECTIVE LENS	RETICLE OPTIONS	TRAVEL PER ROTATION	WEIGHT	LENGTH	FIELD OF VIEW AT 100 YARDS	EYE RELIEF (MAX POWER)	TURRET STYLE
5-20 x 50 FFP	EBR-1 MOA EBR-2B MOA EBR-2B MRAD EBR-3 MRAD	15 MOA or 25 MOA 25 MOA 5 MRAD or 10 MRAD 5 MRAD or 10 MRAD	35.2 oz	15.8"	22.0 - 5.76'	3.9"	Tactical

35mm Tube

Dual Use: Shooting Tactical / Hunting

US Patent 7,937,879 US Patent 7,958,665



VIPER® PST™

PRECISION/SHOOTING/TACTICAL RIFLESCOPES

ADDED NEW
MODELS
FOR 2014

RIFLESCOPES

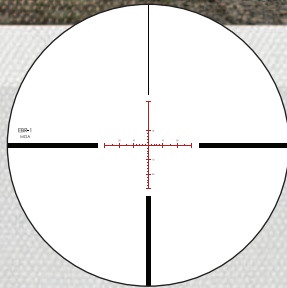

EBR-1 MOA

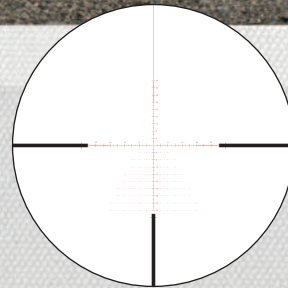

EBR-2C MOA

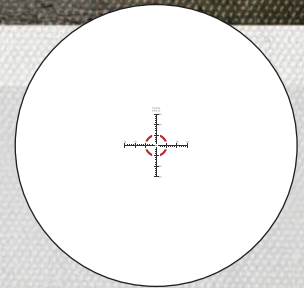

TMCQ MOA

New for 2014, the EBR-2C is a hashmarked ranging reticle for 6-24x50 FFP models using MOA or MRAD-based subtension lines for ranging, holdover and windage corrections. Includes windage reference dots on drop lines.

Close-up views of reticle shown here. See pages 34-35 for more detailed information on available reticles.



6-24 X 50
30MM TUBE

Patented Design



CUSTOMIZABLE ROTATIONAL STOP (CRS):

CRS (Customizable Rotational Stop) system prevents turret from traveling more than one revolution below sight-in zero. After the rifle is sighted in, the design of the CRS allows a shooter to quickly and easily return to an original zero point after using the elevation turret to dial in temporary bullet drop corrections. Available on all tactical turret models.



YOU'RE NOT THE ONLY ONE obsessed with precision.

The Viper® PST™ (Precision Shooting Tactical) is designed and built to deliver consistently repeatable accuracy. Available in either the first or second focal plane, the Viper PSTs are built on one-piece 30mm tubes machined from aircraft-grade aluminum for optimum strength and rigidity – and ample room for elevation adjustment. With XD extra-low dispersion glass objectives offering superior resolution and color along with the durability to withstand the harshest conditions, it is no mystery why the Viper PST is a widely adopted favorite among serious shooters.



1-4 X 24
30MM TUBE



2.5-10 X 32 FFP
30MM TUBE

FEATURES

VIPER PST



XD™ extra-low dispersion glass increases resolution and color fidelity, resulting in crisp, sharp images.

XR™ fully multi-coated lenses increase light transmission for optimal brightness.

ArmorTek® protects exterior lenses from scratches, oil and dirt.

Argon gas purging with o-ring seals guarantees superior fogproof and waterproof performance.

Shockproof construction withstands recoil and impact.

One-piece, aircraft-grade aluminum alloy construction.

30mm diameter main tube with hard-anodized black matte finish.

Matching turrets and reticles in mrad or MOA.

Illuminated glass-etched ranging reticle.

First and second focal plane reticle models.

CRS™ (Customizable Rotational Stop) system prevents turret from traveling more than one revolution below sight-in zero.

Fast-focus eyepiece.

Exposed tactical turrets.

MAG-View™ fiber optic reference.

4x zoom range.

VIPER PST RIFLESCOPES

MAGNIFICATION x OBJECTIVE LENS	RETICLE OPTIONS	WEIGHT	LENGTH	FIELD OF VIEW AT 100 YARDS	EYE RELIEF (MAX POWER)	TURRET STYLE
6-24 x 50 FFP	EBR-1 MOA, EBR-1 MRAD *EBR-2C MOA, *EBR-2C MRAD	23.4 oz	15.5"	17.8 - 5.1'	4.0"	Tactical
4-16 x 50 FFP	EBR-1 MOA, EBR-1 MRAD	22.4 oz	13.7"	27.4 - 7.4'	4.0"	Tactical
2.5-10 x 32 FFP	EBR-1 MOA, EBR-1 MRAD	18.7 oz	12.8"	47.0 - 10.9'	4.0"	Tactical
6-24 x 50	EBR-1 MOA, EBR-1 MRAD	23.4 oz	15.5"	17.8 - 5.1'	4.0"	Tactical
4-16 x 50	EBR-1 MOA, EBR-1 MRAD	22.4 oz	13.7"	27.4 - 7.4'	4.0"	Tactical
2.5-10 x 44	EBR-1 MOA, EBR-1 MRAD	18.8 oz	12.0"	47.0 - 10.9'	4.0"	Tactical
1-4 x 24	TMCQ MOA, TMCQ MRAD	16.2 oz	9.7"	98.0 - 27.5'	4.0"	Tactical
1-4 x 24	TMCQ MOA	14.4 oz	9.7"	98.0 - 27.5'	4.0"	Low Capped

30mm
Tubes

* New Model for 2014 Dual Use: Shooting Tactical / Hunting

US Patent 7,937,879



VIPER® HS-T™

HUNTING/SHOOTING/TACTICAL RIFLESCOPES

COMPLETELY
NEW
FOR 2014

MISSION NOT SO IMPOSSIBLE.

When we set out to close the gap between our Viper® HS™ and our Viper® PST™ riflescopes, we'd have to admit the challenge was a big one. But, with considerable engineering, innovation and focus, we're proud to unveil the new Viper® HS-T. Combining many of the most popular features of our best-selling Viper HS and Viper PST riflescopes, the Viper HS-T is a versatile, high-performance crossover scope for precision shooters. Available in MOA and mrad models, the Viper HS-T boasts an all-new, hashmark-based second-focal-plane reticle, perfect for accurate holds at extended ranges. Mrad reticle hashes subtend in .5 and full-value increments while MOA reticle hashes subtend in 2 MOA increments.

The Viper HS-T scopes also feature incredibly precise, repeatable and durable tactical windage and elevation turrets with our unique CRS (Customizable Rotational Stop) system that allows shooters to quickly re-index their turret after making temporary elevation corrections. The 30mm, one-piece, machined-aluminum tube allows ample reticle travel for extreme adjustments. An ultra-friendly eye box with generous 4-inch eye relief and fast-focus eyepiece puts shooters on target with ease. XD™ (extra-low dispersion) glass guarantees sharp, crisp, edge-to-edge images, and all lens' surfaces are fully multicoated with Vortex's proprietary XR™ coatings to deliver superior light transmission in critical low light situations.

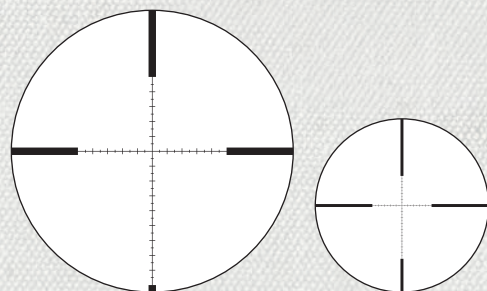

VMR-1 RETICLE

New for 2014, the VMR-1 (Vortex Milling Reticle) is a hashmarked ranging reticle using MOA or MRAD-based subtension lines for ranging, holdover and windage corrections.

Close-up views of reticle shown here. See page 36 for more detailed information on available reticles.

FIRST FOCAL PLANE VERSUS SECOND FOCAL PLANE RIFLESCOPES

All riflescope reticles can be termed either first focal plane (FFP) or second focal plane (SFP) depending upon their internal location within the riflescope. FFP reticles are located in the front of the erector tube near the windage and elevation turrets; SFP reticles are located in the eyepiece assembly.

First Focal Plane Reticles (FFP)

This style of reticle will appear to grow or shrink in size as the magnification changes; reticle details appear heavier at higher magnifications and finer at lower magnifications. The main advantage of an FFP reticle is that the reticle subtensions used for ranging, holdover, and wind drift correction are consistent at all magnifications.

Second Focal Plane Reticles (SFP)

This style of reticle will not change in size as the magnification changes. The advantage of a SFP reticle is that the reticle maintains the same appearance at all magnifications. Reticle subtensions used for ranging, holdover and wind correction are only valid at a single magnification—generally the highest.

4-16 X 44
30MM TUBE6-24 X 50
30MM TUBE**EXPOSED TACTICAL-STYLE TURRETS**

Exposed tactical turrets provide fast, accurate and easily read elevation and windage adjustments.

FEATURES

VIPER HS-T



XD™ extra-low dispersion glass increases resolution and color fidelity, resulting in crisp, sharp images.

XR™ fully multi-coated lenses increase light transmission for optimal brightness.

ArmorTek® protects exterior lenses from scratches, oil and dirt.

Argon gas purging with o-ring seals guarantees superior fogproof and waterproof performance.

Shockproof construction withstands recoil and impact.

One-piece, aircraft-grade aluminum alloy construction.

30mm diameter main tube with hard-anodized black matte finish.

Matching turrets and reticles in mrad or MOA.

CRS™ (Customizable Rotational Stop) system prevents turret from traveling more than one revolution below sight-in zero.

Fast-focus eyepiece.

Exposed tactical turrets.

MAG-View™ fiber optic reference.

4x zoom range.

VIPER HS-T RIFLESCOPES

	MAGNIFICATION x OBJECTIVE LENS	RETICLE OPTIONS	WEIGHT	LENGTH	FIELD OF VIEW AT 100 YARDS	EYE RELIEF (MAX POWER)	TURRET STYLE
30mm Tubes	* 6-24 x 50	VMR-1 MOA, VMR-1 MRAD	22.6 oz	15.5"	17.8 - 5.1'	4.0"	Tactical
	* 4-16 x 44	VMR-1 MOA, VMR-1 MRAD	20.8 oz	13.7"	27.4 - 7.4'	4.0"	Tactical

* New Model for 2014 Dual Use: Shooting Tactical / Hunting



SPITFIRE™

PRISM SCOPES



ACTUALLY, YES, it is a matter of life and death.

COMPLETELY
NEW
FOR 2014

The new Spitfire™ combines an impressive array of high-performance features into a rugged, ultra-compact package. Available in a choice of fixed 1X or 3X models, the Spitfires excel in close- to medium-range shooting applications when fast target acquisition in stressful conditions is a priority. The sophisticated prism-based design allows for a more compact optical system without sacrificing optical quality. Selectable red/green illuminated reticles – with five intensity levels to match specific conditions – are etched directly on the prism to assure consistent point of aim at all times, regardless if illumination is engaged.

SPITFIRE 3x



SPITFIRE 1x



FEATURES

SPITFIRE



Fully multi-coated with anti-reflective lens coatings for brighter views.

Nitrogen gas purging with o-ring seals delivers fogproof, waterproof performance.

Shockproof construction withstands recoil and impact.

Prism-based design delivers sharp images.

Compact, rugged chassis.

Hard-anodized black matte finish.

Illumination control offers red/green option with five levels of brightness.

Multi-height mount system.

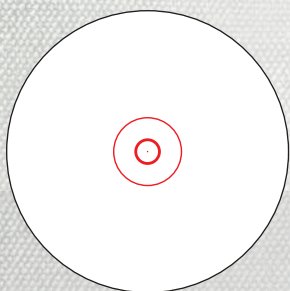

SPITFIRE 1X DRT MOA RETICLE

New for 2014, the DRT (Dual Ring Tactical) reticle is designed for rapid shooting at close distances. The dual ring design pulls the eye into instant alignment with the reticle center and target.

Close-up views of reticle shown here. See page 37 for more detailed information on available reticles.

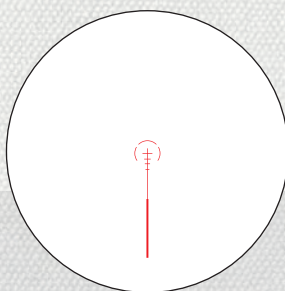

SPITFIRE 3X EBR-556B MOA RETICLE

New for 2014, the EBR-556B is a BDC reticle designed around the 5.56 x 45 cartridge. Reticle will aid in rapid shooting at both near and far ranges. Provides holdover and ranging references from 0-500 yards.

BATTERY LIFE: Typical battery life of 250 hours at maximum brightness setting and 3,000 hours at minimum brightness setting. CR 2032 battery included.



SPITFIRE PRISM SCOPES

MAGNIFICATION	RETICLE OPTIONS	WEIGHT	LENGTH	FIELD OF VIEW AT 100 YARDS	EYE RELIEF
* 3x	EBR-556B MOA	12.2 oz (15.4 oz with Mount)	5.5"	31.5'	2.8"
* 1x	DRT MOA	8.7 oz (11.2 oz with Mount)	4.0"	75.0'	3.7"

* New Model for 2014 Dual Use: Shooting Tactical / Hunting





REPEAT AFTER US: Fast, accurate and deadly.



////////////////////// **RAZOR**[®]
RED DOTS

When you shoulder an AR-15 or comparable piece of armament, everybody knows you mean business. Add a compact Razor[®] red dot, and the whoa factor goes up exponentially. The highly polished glass is crisp from edge to edge. Exceptional resolution and a wide field of view present a sight picture sure to impress. The daylight bright red dot is easy to see and paints targets regardless of lighting conditions or the background. Whether you shoot at paper or protein, the unrivaled reliability and versatility of this high-end reflex sight checks off all the boxes in terms of fast, accurate and deadly. And then some.

Reticle choice of 3 MOA or 6 MOA daylight bright red dot.

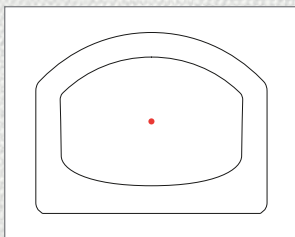

3 MOA DOT

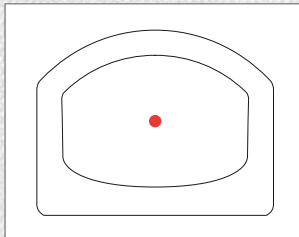

6 MOA DOT

FEATURES
RAZOR



Premium wide-field lens with exceptional edge-to-edge resolution.

XR™ fully multi-coated lenses increase light transmission for optimal brightness.

ArmorTek® protects exterior lenses from scratches, oil and dirt.

Waterproof with o-ring seals.

Shockproof construction withstands recoil and impact.

Ultra compact and rugged with one-piece aircraft-grade aluminum alloy chassis.

Hard-anodized black matte finish.

Unlimited eye relief for rapid target acquisition.

Choice of 3 MOA or 6 MOA dot.

VERSATILE MOUNTING OPTIONS AVAILABLE

Using the versatile multi-height mounting system, the Razor mounts to ARs, handguns or shotguns.



Truly at home on an AR, pistol, shotgun or offset-mounted alongside your primary magnified optic, the compact Razor ensures rapid, accurate target acquisition – every time.

LONG BATTERY LIFE

BRIGHTNESS SETTING

Average Battery Use at Highest Setting	1 year
--	--------

Powered by readily available CR 2032 battery. Auto shut-off after six hours if no button is pressed. Side-opening battery tray.

RAZOR RED DOT

MAGNIFICATION	DOT COLOR	DOT SIZE	WEIGHT	LENGTH	EYE RELIEF
1x	Bright Red	3 MOA	1.4 oz (2.5 oz with Low Mount)	1.8"	Unlimited
1x	Bright Red	6 MOA	1.4 oz (2.5 oz with Low Mount)	1.8"	Unlimited

Dual Use: Shooting Tactical / Hunting



SPARC® II

RED DOTS

MASSIVELY THOUGHT OUT – IN A MINIMALIST KIND OF WAY.

Ultra-compact and lightweight, with a one-piece body machined from aircraft grade aluminum, the 1x magnification SPARC® II is equally at home mounted on an AR15 or shotgun. The daylight-bright, adjustable 2 MOA red dot is powered by a long-lasting CR 2032 lithium battery. The o-ring sealed construction makes the SPARC II waterproof – including submersible and nitrogen purging guarantees fogproof performance. Complete with a multi-height mount system.



Includes versatile multi-height mount system.

Patent Pending



HIGH OR LOW MOUNTS

The versatile multi-height mount system accommodates most firearms, including AR-15s needing absolute or lower 1/3 co-witness heights, and mounts on standard Weaver or Picatinny bases (not included).

VERSATILE MOUNTING OPTIONS AVAILABLE



Mounted on AR-15



Mounted on Handgun or Pistol

VMX-3T AVAILABLE FOR 1X MODEL



Go from 1x to 3x in one quick move. Add the ultimate in magnified versatility to your red dot sight with the VMX-3T™ 3x magnifier. See page 17.

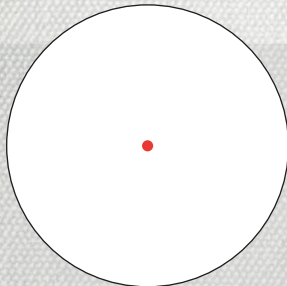

RED DOT

Close-up views of reticle shown here. See pages 34-35 for more detailed information on available reticles.

LONG BATTERY LIFE

DOT COLOR	Bright Red
MAXIMUM BRIGHTNESS	300 hours
MINIMUM BRIGHTNESS	5,000 hours

CR2032 Battery



BATTERY HOLDER AVAILABLE



SPARC II RED DOT

MAGNIFICATION	DOT COLOR	DOT SIZE	WEIGHT	LENGTH	EYE RELIEF
* 1x	Bright Red	2 MOA	5.9 oz	3.1"	Unlimited

* New Model for 2014 Dual Use: Shooting Tactical / Hunting



COMPLETELY
NEW
FOR 2014

RED DOTS

14

FEATURES

SPARC II



Fully multi-coated with anti-reflective lens coatings for brighter views.

Nitrogen gas purging with o-ring seals delivers fogproof, waterproof performance.

Shockproof construction withstands recoil and impact.

Compact, lightweight, one-piece chassis.

Hard-anodized black matte finish.

Unlimited eye relief for rapid target acquisition.

Daylight bright red 2 MOA dot.

Multi-height mount system.



STRIKEFIRE® II

RED DOTS

TURN IT ON, and it's lights out.

When the situation requires fast shooting to get the job done, a big scope with a narrow field of view isn't on the list. Mount up the all-new StrikeFire® II and shoot with both eyes open. With unlimited field of view and eye relief, nothing gets you on target faster than this tough, compact little red dot scope. Shockproof and waterproof, the StrikeFire II is offered with either Bright Red or Red/Green illumination. Adjustable dot intensity perfectly matches any lighting.

COMPLETELY
NEW
FOR 2014



Patent Pending

FEATURES



STRIKEFIRE II

Fully multi-coated with anti-reflective lens coatings for brighter views.

Nitrogen gas purging with o-ring seals delivers fogproof, waterproof performance.

Shockproof construction withstands recoil and impact.

Rugged, one-piece aluminum alloy chassis.

Hard-anodized black matte finish.

Unlimited eye relief for rapid target acquisition.

4 MOA Red/Green or Bright Red dot option.

Lower 1/3 co-witness cantilever mount or low ring mount option.



40MM OR 21MM MOUNTS

The mounted height of the StrikeFire® II depends on the version purchased. The models with a 40mm cantilever ring provide lower 1/3 co-witness for flat top AR-15 rifles with iron sights. The 21mm ring is commonly used for mounting on most other rifles, shotguns and handguns.



VMX-3T™ 3X MAGNIFIER See page 17.
With high quality optics and an included Flip Mount, increase the effective range of your red dot sight with the push of a button.



RED DOT

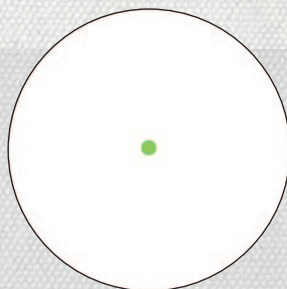

GREEN DOT

Close-up views of reticle shown here. See pages 34-35 for more detailed information on available reticles.

BATTERY LIFE: The StrikeFire II's sophisticated circuitry shuts the unit down after five hours. Average CR2 battery life depends on the dot intensity setting and color.

DOT COLOR	MAXIMUM BRIGHTNESS	MINIMUM BRIGHTNESS
Bright Red	400 hours	7,000 hours
Red/Green	300 hours	6,000 hours

CR2 Battery

STRIKEFIRE II RED DOT

MAGNIFICATION	DOT COLOR	DOT SIZE	WEIGHT	LENGTH	EYE RELIEF	TUBE SIZE	RING HEIGHT OPTION
* 1x	Red / Green	4 MOA	7.2 oz	5.6"	Unlimited	30mm	40mm or 21mm
* 1x	Bright Red	4 MOA	7.2 oz	5.6"	Unlimited	30mm	40mm

* New Model for 2014 Dual Use: Shooting Tactical / Hunting



ACCESSORIES

FOR RIFLESCOPES



RAZOR 35MM RINGS

Developed specifically for the Razor® HD 5-20x50mm tactical riflescope, our 35mm steel rings are precision-machined for a rock-solid, durable mount.



VIPER RIFLESCOPE RINGS

Sleek, light weight and durable, the Viper rings use four T-15 Torx-style socket cap screws for secure mounting of your riflescope. Rings allow quick-and-easy mounting and can remain on scope when detached from base.



TACTICAL RINGS

Wide 6-screw ring offers solid support for 30mm riflescope tubes.



PRECISION-MATCHED RINGS

Machined in pairs that are kept together throughout the manufacturing process to ensure perfection from one set to another. Our Precision Matched Rings are held to an extremely tight tolerance of .0005 and are serialized, vibratory tumbled, hand-head blasted, and finished off with a Type III hard coat anodize.

CANTILEVER MOUNTS



CANTILEVER 30MM RINGS

Provide extra rail room for rear BUIS when using the StrikeFire red dot along with the VMX-3T magnifier. The cantilever ring will move the StrikeFire forward about one inch.



QUICK RELEASE CANTILEVER RING MOUNT

Vortex Quick Release cantilever ring mounts provide the correct height and forward placement necessary for proper scope mounting on flat top ARs. Extreme duty ADR model features quick-detach auto lock design. 30mm ring diameter. Available in two and three inch offset models.



CANTILEVER RING MOUNT

Vortex cantilever ring mounts provide the correct height and forward placement necessary for proper scope mounting on flat top ARs. Available in one inch and 30mm ring sizes with a two or three inch offset.

RIFLESCOPE RINGS

Razor 35mm Rings [Height from base] *Sold two per package.*
35mm Tube: 1.00 inch [25.4mm]

Precision Matched Rings [Height from base] *Sold two per package.*

35mm Tube: Medium [.95 inches / 24.13mm] | Medium-Plus [1.00 inches / 25.4mm] High [1.26 inches / 32mm]

34mm Tube: Medium [.92 inches / 23.4mm] | Medium-Plus [1.00 inches / 25.4mm] High [1.26 inches / 32mm]

30mm Tube: Low [.87 inches / 22.1mm] | Medium [.97 inches / 24.64mm] High [1.26 inches / 32mm]

Viper Rings [Height from base] *Sold two per package.*

30mm Tube: Low [.87 inches / 22.09mm] | Medium [.97 inches / 24.64mm] High [1.12 inches / 28.44mm]

1-Inch Tube: Low [.78 inches / 19.81mm] | Medium [.88 inches / 22.35mm] High [1.03 inches / 26.16mm]

Tactical Rings [Height from base] *Sold individually.*

30mm Tube: Low [.83 inches / 21mm] | Medium [.97 inches / 24.6mm] High [1.18 inches / 30mm]

Extra High, Absolute Co-Witness [1.46 inches / 37mm]
 Extra High, Lower 1/3 Co-Witness [1.57 inches / 40mm]

Cantilever Ring Mounts

30mm Tube [Height from base]

Extreme duty ADR mount with quick release

2-Inch Offset: [1.47 inches / 37.34mm]

3-Inch Offset: [1.47 inches / 37.34mm]

30mm Tube [Height from base]

Standard mount

2-Inch Offset: [1.59 inches / 40.39mm]

3-Inch Offset: [1.59 inches / 40.39mm]

Cantilever 30mm Rings [Height from base]

Absolute Co-Witness: [1.46 inches / 37mm]

Lower 1/3 Co-Witness: [1.57 inches / 40mm]

Switchview™ Throw Levers [Magnification Ring Diameter]

SV-1: [1.669 inches / 42mm]

Compatible with Viper® PST™ and Viper® HS™ riflescopes with rubber magnification rings.

SV-2: [1.739 inches / 44mm]

Compatible with Razor® HD riflescopes with rubber magnification rings; Viper® PST™ and Viper® HS™ riflescopes with metal magnification rings.

SV-3: [1.930 inches / 49mm]

Compatible with Razor® HD Gen II riflescopes with metal magnification rings.



RIFLESCOPE BUBBLE LEVEL

Designed to maximize accuracy. A Vortex bubble level makes it easy to maintain a perfect horizontal hold during extreme-range shooting. Available for 1-inch, 30mm, 34mm and 35mm riflescopes tubes.



SWITCHVIEW™ THROW LEVER

Maximize the efficiency of magnification transitions with fluid precision using Vortex's Switchview™ throw lever. Attaches and detaches easily to Razor® HD, Viper® PST™ and Viper® HS™ power rings. Constructed of skeletonized, light-weight, tough, hard-coat anodized machined aluminum.



BATTERY HOLDER

Be prepared with a back-up battery. This watertight, dustproof battery holder conveniently mounts on a Picatinny rail and holds one CR 2032 battery.



RIFLESCOPE STRETCH COVER

Keep your riflescopes protected from the elements with a Vortex riflescopes cover. Durable material stretches to fit a range of models and configurations. Finger loop on end, along with its simple design provides fast and easy on/off convenience.

ACCESSORIES

FOR RED DOTS

VMX-3T™ MAGNIFIER AND MOUNT – GO FROM 1X TO 3X IN ONE QUICK MOVE.

Add the ultimate in magnified versatility to your red dot sight with the VMX-3T™ 3x magnifier. With high quality optics and an included Flip Mount, increase the effective range of your red dot sight with the push of a button.



- Nitrogen purged for fogproof, waterproof performance.
- Fully multi-coated for bright views.
- Hard-anodized matte black finish for added protection.
- Flip Mount provides magnified and unmagnified viewing.
- Allows either Lower 1/3 or Absolute Co-Witness mounting heights.

Use the included Flip Mount to quickly switch from unmagnified to magnified viewing.



ROTATED TO OFFSET POSITION

SIZE (H x W)	MAGNIFIER WEIGHT	MOUNTED WEIGHT	FIELD OF VIEW (100 YARDS)	EYE RELIEF
1.7" x 4.3"	7.6 oz	11.9 oz	38.2'	2.2"



VMX-3T™ shown with StrikeFire II.



ENGAGED POSITION



VORTEX®

BINOCULARS/SPOTTING SCOPES // // // // // Binoculars p. 20-24 | Rangefinders p. 25 | Monoculars p. 26-27 | Spotting Scopes p. 28-29

THE FORCE OF OPTICS

2014



BINOCULARS
& SPOTTERS

BINOCULARS / SPOTTERS / MONOCULARS

PROTECT AND OBSERVE —

SURVEILLANCE AT ITS FINEST.

TACTICAL SITUATIONS CALL FOR THE VERY BEST. IN FACT, THEY CALL FOR VORTEX. FROM TACTICAL BINOCULARS TO SPOTTING SCOPES, OUR OPTICS ARE FINE-TUNED AND DIALED-IN TO EVERY IMAGINABLE SITUATION. THE PREMIUM-GRADE OPTICS AND PRECISION ENGINEERING PUNCTUATE PERFORMANCE FEATURES. WATERPROOF, SHOCKPROOF, FOGPROOF — THEY ARE ALL DESIGNED TO OUTPERFORM IN THE WORST CONDITIONS — INCLUDING HELL ON EARTH.

TACTICAL OPTICS | THE FORCE OF OPTICS



RAZOR® HD

FULL SIZE ROOF PRISMS

SOME PEOPLE MAY QUESTION YOUR SANITY.
 These are usually people who spend their day in front of a desk.



Extreme terrain, unimaginable conditions. While others might question your mental state, you remain focused on the task at hand. A task, mind you, that can be accomplished with a pair of Vortex Razor® HDs. With a well-earned reputation for pushing the limits of optical performance, the Razor HDs step up and out on binoculars in their class. Small, light, bright, strong and packed with the best-quality, hand-selected prisms and premium HD/extra-low dispersion glass available today, there is simply nothing left to question.

FEATURES



APO optical system combined with HD glass provides unmatched color sharpness.

HD (High Density) extra-low dispersion glass delivers impressive resolution and color fidelity, resulting in High Definition images.

XR*Plus*™ premium fully multi-coated lenses deliver the highest level of light transmission for maximum brightness.

Dielectric multi-layer prism coatings provide bright, clear, color-accurate images.

Plasma Tech™ – Cutting edge application process provides unparalleled coating durability and performance.

ArmorTek® protects exterior lenses from scratches, oil and dirt.

Argon gas purging with o-ring seals guarantees superior fogproof and waterproof performance.

Phase-corrected prisms for sharp images and contrast.

Magnesium chassis decreases weight and increases strength.

Rubber armor provides rugged durability and a secure, non-slip grip.

True Open Hinge™ offers superior ergonomics while decreasing total weight and bulk.

Locking diopter.

BINOCULARS

20

SMALLER. LIGHTER. CLEARER. STRONGER.

As technologies progress, so will our flagship binocular – the Razor. And thanks to the many cutting-edge features, our Razors lead the Vortex binocular line-up into the future with an incredible pair of optics. Smaller, lighter, clearer and stronger – look through a pair, you will be notably impressed.



RAZOR HD BINOCULARS

MAGNIFICATION x OBJECTIVE LENS	EYE RELIEF ADJUSTMENT	CLOSE FOCUS DISTANCE	FIELD OF VIEW 1000 YARDS / DEGREES	WEIGHT	HEIGHT x WIDTH	INTERPUPILLARY DISTANCE
12 x 50	15.5mm	10.0'	285.0' / 5.4°	28.7 oz	6.8 x 5.1"	57-74mm
10 X 50	16.5mm	10.0'	315.0' / 6.0°	28.1 oz	6.8 x 5.1"	57-74mm
10 X 42	16.5mm	6.0'	362.0' / 6.9°	24.8 oz	5.9 x 5.1"	55-75mm
8 X 42	17.5mm	6.0'	388.0' / 7.4°	24.2 oz	5.9 x 5.1"	55-75mm

FULL SIZE ROOF PRISMS





KAIBAB® HD

FULL SIZE ROOF PRISMS

COMPLETELY
NEW
FOR 2014

FEATURES

KAIBAB HD



APO optical system combined with HD glass provides unmatched color sharpness.

HD (High Density) extra-low dispersion glass delivers impressive resolution and color fidelity, resulting in High Definition images.

XRPlus™ premium fully multi-coated lenses deliver the highest level of light transmission for maximum brightness.

Dielectric multi-layer prism coatings provide bright, clear, color-accurate images.

Plasma Tech™ – Cutting edge application process provides unparalleled coating durability and performance.

ArmorTek® protects exterior lenses from scratches, oil and dirt.

Argon gas purging with o-ring seals guarantees superior fogproof and waterproof performance.

Phase-corrected prisms for sharp images and contrast.

Rugged rubber armor provides a secure, non-slip grip.

56mm objective maximizes low-light performance.

Locking diopter.

RELIABLE, CRYSTAL-CLEAR RECON.

Try getting that from your brother-in-law.

The ultimate long-range binocular, the Kaibab® HD leaves little to the imagination. Every detail – even at extreme long ranges – is revealed in vivid high-definition color. Every speck is translated into opportunity. Pushing the performance envelope, the Kaibab® HD offers the power and optical features you need to dissect the landscape. Superior images, stunning resolution and, of course, incredible power. When it comes to “do-it-yourself or else” – the Kaibab delivers.

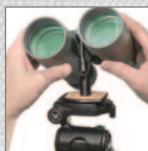

UNI-DAPTOR TRIPOD MOUNT

Included with the Kaibab HD, the Uni-Daptor is a slim, lightweight, quick-detaching tripod mount.

KAIBAB HD BINOCULARS

	MAGNIFICATION x OBJECTIVE LENS	EYE RELIEF ADJUSTMENT	CLOSE FOCUS DISTANCE	FIELD OF VIEW 1000 YARDS / DEGREES	WEIGHT	HEIGHT x WIDTH	INTERPUPILLARY DISTANCE
FULL SIZE ROOF PRISM	*20 x 56	15.0mm	23.0'	168' / 3.2°	43.6 oz	7.7 x 5.7"	60-76mm
	*15 x 56	15.0mm	23.0'	215' / 4.1°	43.9 oz	7.7 x 5.7"	60-76mm

* New Model for 2014



VIPER® HD R/T

FULL SIZE ROOF PRISMS



FEATURES

VIPER HD R/T



HD (High Density) extra-low dispersion glass delivers impressive resolution and color fidelity, resulting in High Definition images.

XR™ fully multi-coated lenses increase light transmission for optimal brightness.

Dielectric multi-layer prism coatings provide bright, clear, color-accurate images.

ArmorTek® protects exterior lenses from scratches, oil and dirt.

Argon gas purging with o-ring seals guarantees superior fogproof and waterproof performance.

Ranging reticle for fast estimates of distance.

Phase-corrected prisms for sharp images and contrast.

Rugged rubber armor provides a secure, non-slip grip.

PRECISION-PERFORMANCE OPTICS

completely change the game.

The Viper® HD R/T tactical binocular combines award-winning optics and tactical features to create a tough, durable roof prism binocular – reliable in the worst conditions. Now with HD extra-low dispersion glass objective lenses to further enhance resolution and deliver the true-to-life color accuracy required for identifying targets at long distances in low light. And, with the R/T ranging reticle – which features four silhouettes to serve as a secondary ranging aid – you can easily range objects of known dimension.

R/T RANGING RETICLE

Ranging reticle for the Recon R/T uses mrad based subtensions. These angular measurements allow a user to calculate ranges when comparing the reticle to objects of known dimension. Also includes silhouettes for quick ranging.

US Patent 7,877,866

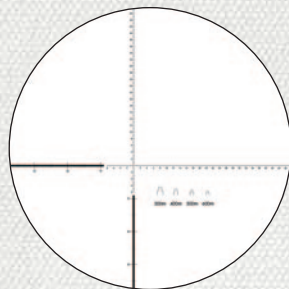

Quick ranging silhouettes.

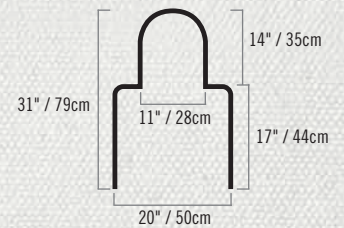

CLOSE-UP VIEW

VIPER HD R/T BINOCULARS

	MAGNIFICATION x OBJECTIVE LENS	EYE RELIEF ADJUSTMENT	CLOSE FOCUS DISTANCE	FIELD OF VIEW 1000 YARDS / DEGREES	WEIGHT	HEIGHT x WIDTH	INTERPUPILLARY DISTANCE
FULL SIZE ROOF PRISMS	* 10 x 50 HD R/T	20.0mm	8.2'	278' / 5.3°	27.2 oz	6.7 x 5.2"	59-75mm

* New Model for 2014





TACTICAL COMPACTS

engineered with amazing vision.

VIPER® R/T

COMPACT ROOF PRISMS



The Viper® R/T tactical binocular combines award-winning optics and tactical features to create a tough, durable roof prism binocular – reliable in the worst conditions. XD™ (extra-low dispersion glass) objective lenses enhance resolution and deliver the true-to-life color accuracy so essential for identifying targets. Range objects of known dimension with the R/T ranging reticle, which features four silhouettes to serve as a secondary ranging aid.

FEATURES

VIPER R/T COMPACT



XD™ extra-low dispersion glass increases resolution and color fidelity, resulting in crisp, sharp images.

XR™ fully multi-coated lenses increase light transmission for optimal brightness.

Dielectric multi-layer prism coatings provide bright, clear, color-accurate images.

ArmorTek® protects exterior lenses from scratches, oil, and dirt.

Argon gas purging with o-ring seals guarantees superior fogproof and waterproof performance.

Ranging reticle for fast estimates of distance.

Phase corrected prisms for sharp images and contrast.

Rugged rubber armor provides a secure, non-slip grip.

VIPER R/T COMPACT BINOCULARS

	MAGNIFICATION x OBJECTIVE LENS	EYE RELIEF ADJUSTMENT	CLOSE FOCUS DISTANCE	FIELD OF VIEW 1000 YARDS / DEGREES	WEIGHT	HEIGHT x WIDTH	INTERPUPILLARY DISTANCE
COMPACT ROOF PRISMS	8 x 28 R/T	20.0mm	7.5'	319' / 6.1°	11.8 oz	4.7 x 4.5"	56-73mm



HURRICANE®

FULL SIZE PORRO PRISM

LONG-RANGE SURVEILLANCE IN THE WORST CONDITIONS. Done.



Bring it on: the roughest conditions, the wettest weather and the harshest climates. You're ready for it – and so is your Hurricane® binocular. Built to endure all of the above, they feature a ruggedly built, porro-prism design, with individually focused eyepieces, non-slip/non-skid rubber armor housings and 100% waterproof/shockproof/fogproof/dustproof construction. All lens surfaces are fully multi-coated with Vortex's XR™ anti-reflective coatings and exterior lens surfaces are protected from scratches, oils and corrosive salts by ArmorTek®. Argon gas purging seals the deal by eliminating internal fogging and corrosion.

BINOCULARS

24



FEATURES HURRICANE



XR™ fully multi-coated lenses increase light transmission for optimal brightness.

ArmorTek® protects exterior lenses from scratches, oil and dirt.

Argon gas purging with o-ring seals guarantees superior fogproof and waterproof performance.

Rugged rubber armor provides a secure, non-slip grip.

Ideal for long-term surveillance.

Individual eyepiece adjustment provides precise focus.

HURRICANE BINOCULARS

	MAGNIFICATION x OBJECTIVE LENS	EYE RELIEF ADJUSTMENT	CLOSE FOCUS DISTANCE	FIELD OF VIEW 1000 YARDS / DEGREES	WEIGHT	HEIGHT x WIDTH	INTERPUPILLARY DISTANCE
FULL SIZE	10 x 50	15.0mm	30.0'	341' / 6.5°	38.4 oz	7.4 x 8.0"	56-74mm
PORRO PRISMS	7 x 50	17.0mm	30.0'	378' / 7.2°	39.4 oz	7.4 x 8.0"	56-74mm





RANGER® 1000

RANGEFINDERS

RANGER 1000



FEATURES

RANGER 1000

Fully multi-coated with anti-reflective coatings for brighter views.

Waterproof with o-ring seals.

Rugged, compact and lightweight.

Rubber armor provides a secure, non-slip grip.

Intuitive, easy-to-use menu.

Simple, clean display.

HCD (Horizontal Component Distance) angle compensated ranging.

Choice of ranging in yards or meters.

Utility clip for quick field access.

AT 11,000 FEET WHO WANTS TO RELY ON pretty good?

Extreme situations where EVERYTHING is difficult is no place to realize your rangefinder is less than a top performer. The Ranger® 1000 rangefinder is a welcome companion – capable in every way. Three ranging modes, up to 1,000 yards, are quickly accessed using an uncomplicated, common sense menu. Fully multi-coated lens surfaces ensure maximum light transmission providing bright, tack-sharp images – making it super easy to range your target. There's even a low-battery indicator, so you know how much power you have available at all times. When there's no room for "pretty good", get it right. Get the Ranger 1000.

THREE RANGING MODES

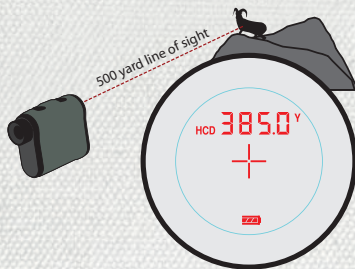

HCD Corrected Shoot-To Range

With accuracy to 1,000 yards, the Ranger 1000 features three ranging modes that are quickly accessed using an uncomplicated, common-sense menu.

1. Horizontal Component Distance (HCD) mode displays the slope angle compensated distance to the target.
2. Scan mode displays distance readings when panning across a landscape or tracking moving targets.
3. Line of Sight (LOS) mode displays the actual line of sight range. This mode will be used by shooters making high angle / long-distance shots in conjunction with slope angle corrected ballistic range cards or an application on a mobile device. Display also shows an Incline Correction number (INC) to adjust bullet drop data for ballistics applications not including slope angle correction.

RANGER 1000 RANGEFINDER

MAGNIFICATION	OBJECTIVE LENS DIAMETER	EYE RELIEF	FIELD OF VIEW AT 1000 YARDS / DEGREES	MIN. REFLECTIVE RANGE	MAX. REFLECTIVE RANGE	WEIGHT	SIZE
6x	22mm	17mm	315' / 6.0°	11 yards	1000 yards	7.7 oz	3.0 x 3.9"



RECON® R/T

MONOCULARS

WHEN EVERY OUNCE COUNTS.

Developed specifically for field surveillance and range estimation, the Recon® R/T delivers superb optical performance using premium XD™ glass and XR™ lens coatings. The versatile attachment clip secures the Recon R/T to any belt or strap for rapid deployment and the R/T ranging reticle, using mrad-based subtensions and secondary quick-ranging silhouettes, allow users to estimate the range of objects of known dimension.



RECON R/T
15 x 50
Patented Design



FEATURES

RECON R/T



XD™ extra-low dispersion glass increases resolution and color fidelity, resulting in crisp, sharp images.

XR™ fully multi-coated lenses increase light transmission for optimal brightness.

ArmorTek® protects exterior lenses from scratches, oil and dirt.

Argon gas purging with o-ring seals guarantees superior fogproof and waterproof performance.

Shockproof construction withstands impact.

Ranging reticle for fast estimates of distance.

Reticle focus ensures a sharp reticle image at all distance.

Phase-corrected prisms for sharp images and contrast.

Compact, lightweight, rubber armored chassis.

Utility clip allows for multiple attachment points and quick field access.

MONOCULARS

26



PICATINNY RAIL

Any accessory using the standard Picatinny rail clamp will attach on either side of the Recon.



FLARED RUBBER EYECUP rotates for a custom fit while assisting to block stray light for better image resolution.

R/T RANGING RETICLE

Ranging reticle for the Recon R/T uses mrad based subtensions. These angular measurements allow a user to calculate ranges when comparing the reticle to objects of known dimension. Also includes silhouettes for quick ranging.

US Patent 7,877,866

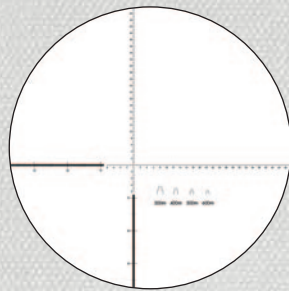

Quick ranging silhouettes.

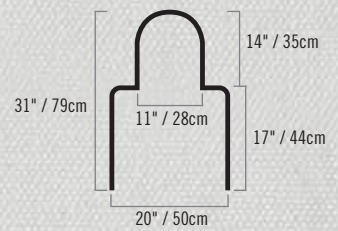
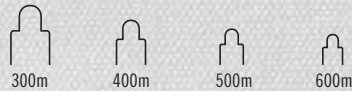

CLOSE-UP VIEW



2X DOUBLER – When the total weight of your gear is critical, keep your options open for long-distance viewing with the help of this lightweight, pocket-sized piece. With the optional Vortex Doubler you can increase the magnification of your Recon R/T.

RECON R/T TACTICAL MONOCULAR

MAGNIFICATION x OBJECTIVE LENS	EYE RELIEF ADJUSTMENT	CLOSE FOCUS DISTANCE	FIELD OF VIEW AT 1000 YARDS / DEGREES	WEIGHT	LENGTH
15 x 50	16.0mm	12.0'	215' / 4.1°	15.2 oz	7.0"
10 x 50	19.5mm	12.0'	280' / 5.3°	15.2 oz	7.0"



US Patent D603,436S



STANDARD ISSUE for high standards.

Built to be carried as a standard piece of equipment and close-at-hand, the Solo® R/T Tactical Monocular gives a closer look when needed. Features the Vortex R/T Ranging Reticle with reticle focus for accurate range estimation and calling shots. The generous eye relief and a large exit pupil deliver optical performance normally reserved for binoculars and the premium roof prisms and fully multi-coated optics deliver a bright, clear view. Completely waterproof and nitrogen purged, with a textured rubber armor and convenient belt or shoulder strap clip – they're good to go. Easy pick.



SOLO 36MM
8x36 R/T

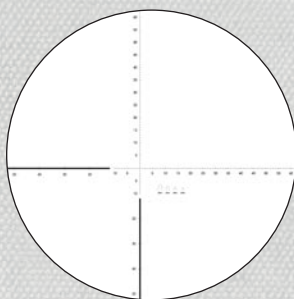

SOLO R/T RANGING RETICLE

The Solo R/T features Vortex's advanced R/T ranging reticle for fast, accurate estimates of distances and ranges with quick-ranging silhouettes and reticle focus. See details on page 38. US Patent 7,877,886

SOLO® R/T MONOCULARS

FEATURES

SOLO R/T



Fully multi-coated with anti-reflective lens coatings for brighter views.

Nitrogen gas purging delivers fogproof, waterproof performance.

Ranging reticle for fast estimates of distance.

Reticle focus ensures a sharp reticle image at all distance.

Super compact and rugged.

Rugged rubber armor provides a secure, non-slip grip.

Contoured design for comfortable handling.

Utility clip allows for multiple attachment points and quick field access.



SOLO R/T MONOCULARS

MAGNIFICATION x OBJECTIVE LENS	EYE RELIEF ADJUSTMENT	CLOSE FOCUS DISTANCE	FIELD OF VIEW 1000 YARDS / DEGREES	WEIGHT	LENGTH
8 x 36 R/T	18.0mm	16.4'	393' / 7.5°	10.2 oz	5.4"



RAZOR® HD

SPOTTING SCOPES

HOW A PERSON OF INTEREST becomes the defendant.

Simply one of the finest spotting scopes you can buy, the Razor® HD competes at the highest level of performance. The sophisticated triplet apochromatic lens system, precision-ground from high-definition optical glass, eliminates nearly all chromatic aberration across the entire field of view. The result? No fringing, no degradation of resolution, no dilution of color fidelity at longer viewing distances. Simply incredible is an understatement. The Razor HDs place Vortex where it counts with respect to its world-renowned spotters.



RAZOR HD 85MM
STRAIGHT

FEATURES

RAZOR HD | 85MM



HD (High Density) premium extra-low dispersion glass delivers the ultimate in resolution and color fidelity, resulting in High Definition images.

XRPlus™ premium fully multi-coated lenses deliver the highest level of light transmission for maximum brightness.

Dielectric multi-layer prism coatings provide bright, clear, color-accurate images.

Plasma Tech™ — Cutting edge application process provides unparalleled coating durability and performance.

ArmorTek® protects exterior lenses from scratches, oil and dirt.

Argon gas purging with o-ring seals guarantees superior fogproof and waterproof performance.

Zoom eyepiece included.

Objective with triplet apochromatic lens system.

Choice of angled or straight eyepiece position.

Compact, die-cast magnesium alloy body.

Dual focus for fast and fine adjustments.

Built-in sunshade reduces glare and shields objective lens.

Rotating tripod collar provides adjustable viewing angles.

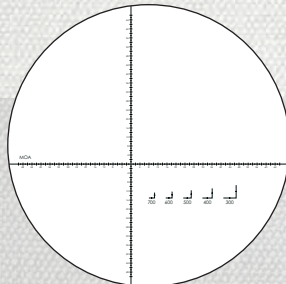

Quick ranging brackets.

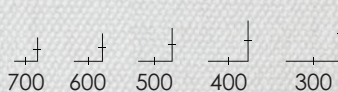

OPTIONAL 30X WA RANGING RETICLE EYEPIECE

30x Wide Angle (WA) spotting scope eyepiece for the 85mm Razor HD promotes fast, forgiving and easy viewing. Hashmark-based MOA and MRAD models facilitate accurate calling of shots in spotter/shooter scenarios as well as range estimation capabilities.

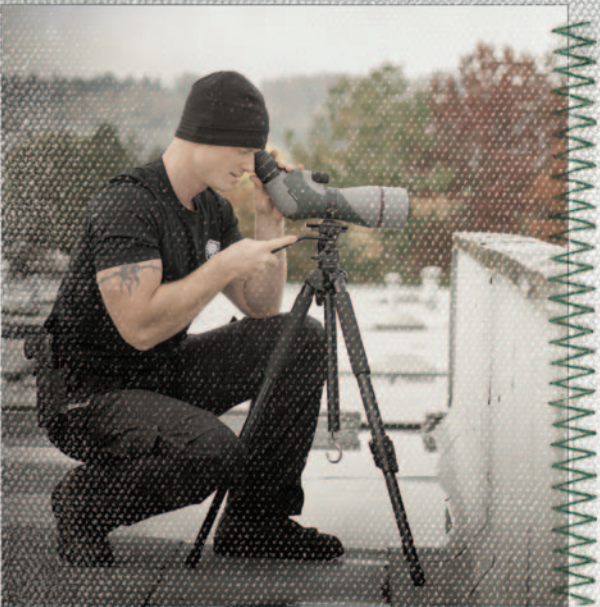

RAZOR HD 85MM ANGLED



AVAILABLE ACCESSORIES:

DIGITAL CAMERA ADAPTER FOR DIGISCOPING

Our Digital Camera Adapter for the Razor® HD spotting scopes easily converts your camera to a high-powered telephoto lens. Works with DSLR cameras and, with the PS-100 attachment, you can easily digiscope with your point-and-shoot camera, too. Super easy to use – making image capturing simple.



Shown here with the adapter on scope.



Optional black fitted case offers a snug, custom fit for optimal protection, ease of handling and streamlined packing.



RAZOR HD FIXED EYEPIECES

Various fixed-power eyepieces are available for use with Razor HD 85mm spotting scopes, including the 23x LER and 30x WA eyepieces.

		MAGNIFICATION x OBJECTIVE LENS	EYEPIECE POSITION	EYE RELIEF ADJUSTMENT	CLOSE FOCUS DISTANCE	FIELD OF VIEW 1000 YARDS / DEGREES	SCOPE WEIGHT	SCOPE LENGTH
85mm MODELS	}	20-60 x 85	Angled	18-20mm	16.4'	117-60' / 2.2-1.1°	65.7 oz	15.3"
		20-60 x 85	Straight	18-20mm	16.4'	117-60' / 2.2-1.1°	65.7 oz	15.8"
FIXED EYEPIECES	}	30x	—	18mm	—	112' / 2.1°	—	—
		30x WA (MOA or MRAD)	—	18mm	—	112' / 2.1°	—	—
		Ranging Reticle	—	18mm	—	112' / 2.1°	—	—
		23x LER	—	31mm	—	103' / 2.0°	—	—



US Patent D595,754S

RAZOR® HD GEN II > FIRST FOCAL PLANE

RIFLESCOPE AND RETICLE SPECIFICATIONS

RAZOR HD GEN II EBR-2C MOA and MRAD RETICLE

Hashmarked ranging reticle using MOA or MRAD based subtension lines for ranging, holdover, and windage corrections. Includes windage reference dots on drop lines.

Letters refer to reticle subtensions listed in chart below.

Note: Reticle images shown for representation only. Reticle image varies between scope models depending on magnification and reticle plane.

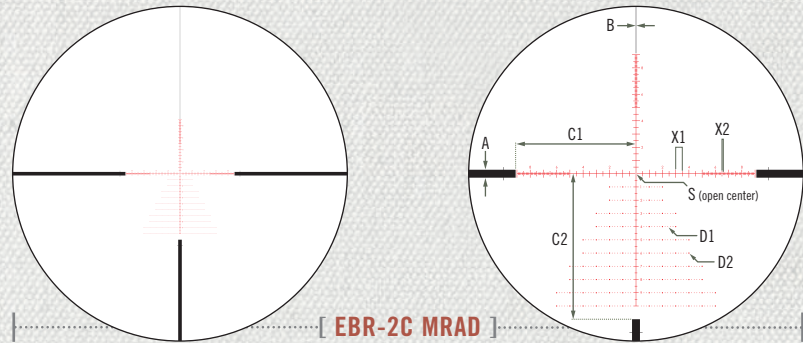
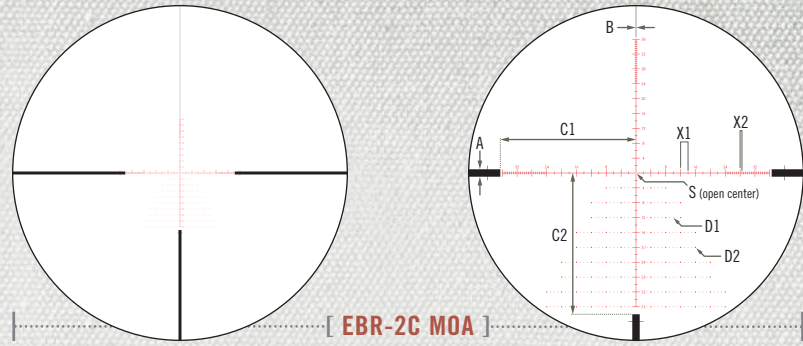

VISIT WWW.VORTEXTACTICAL.COM for specific combinations of reticles and riflescopes.

SPECIFICATIONS

30

RAZOR HD GEN II RIFLESCOPES

MAGNIFICATION x OBJECTIVE LENS	RETICLE STYLE	WEIGHT	EYE RELIEF	FIELD OF VIEW (100 YARDS)	TUBE SIZE	WATERPROOF FOGPROOF	LENS COATINGS	FINISH	ADJUSTMENT GRADUATION	ELEVATION ADJUSTMENT	WINDAGE ADJUSTMENT	TRAVEL PER ROTATION	TURRET STYLE	PARALLAX (YARDS)	VIP WARRANTY
1-6 x 24	JM-1 BDC MOA	25.2 oz	4.0"	115.2 - 20.5'	30mm	Argon Gas	XRPlus	Stealth Shadow	1/2 MOA	150 MOA	150 MOA	50 MOA	Low Capped	100	✓
* 1-6 x 24	VMR-2 MOA	25.2 oz	4.0"	115.2 - 20.5'	30mm	Argon Gas	XRPlus	Stealth Shadow	1/2 MOA	150 MOA	150 MOA	50 MOA	Low Capped	100	✓
* 1-6 x 24	VMR-2 MRAD	25.2 oz	4.0"	115.2 - 20.5'	30mm	Argon Gas	XRPlus	Stealth Shadow	.2 MRAD	43 MRAD	43 MRAD	20 MRAD	Low Capped	100	✓
* 3-18 x 50 FFP	EBR-2C MOA	46.5 oz	3.7"	37.8 - 6.25'	34mm	Argon Gas	XRPlus	Stealth Shadow	1/4 MOA	117 MOA	45 MOA	25 MOA	L-Tec	25 to Infinity	✓
* 3-18 x 50 FFP	EBR-2C MRAD	46.5 oz	3.7"	37.8 - 6.25'	34mm	Argon Gas	XRPlus	Stealth Shadow	.1 MRAD	34 MRAD	13 MRAD	10 MRAD	L-Tec	25 to Infinity	✓
* 4.5-27 x 56 FFP	EBR-1C MRAD	48.5 oz	3.7"	25.3 - 4.4'	34mm	Argon Gas	XRPlus	Stealth Shadow	.1 MRAD	33 MRAD	13 MRAD	10 MRAD	L-Tec	32 to Infinity	✓
* 4.5-27 x 56 FFP	EBR-2C MOA	48.5 oz	3.7"	25.3 - 4.4'	34mm	Argon Gas	XRPlus	Stealth Shadow	1/4 MOA	114 MOA	45 MOA	25 MOA	L-Tec	32 to Infinity	✓
* 4.5-27 x 56 FFP	EBR-2C MRAD	48.5 oz	3.7"	25.3 - 4.4'	34mm	Argon Gas	XRPlus	Stealth Shadow	.1 MRAD	33 MRAD	13 MRAD	10 MRAD	L-Tec	32 to Infinity	✓

* New Model for 2014

[RETICLE SUBTENSIONS]

MODEL	EBR-1C MRAD				EBR-2C MOA				EBR-2C MRAD				VMR-2 MOA				VMR-2 MRAD				JM-1 BDC MOA																			
	A	B	S	X1 X2	A	B	C1	C2 D1 D2 S	X1 X2	A	B	C1	C2 D1 D2 S	X1 X2	A	B1	B2	C1	C2	X	A	B1	B2	C1	C2	X	A	B	C1	C2	D	F	G	H	I					
1-6 x 24	-	-	-	-	-	-	-	-	-	-	-	-	-	-	-	-	-	-	-	1.75	.6	.5	35	45	4	.5	.18	.15	11	11	1	1.5	.5	15	35	.5	2.4	5.6	9.5	14.6
3-18 x 50 FFP	-	-	-	-	2	.14	36.5	38	.2	.3	.25	2	.5	.6	.03	9.1	11	.06	.09	.06	.5	.1	-	-	-	-	-	-	-	-	-	-	-	-	-	-				
4.5-27 x 56 FFP	.6	.03	.06	.5	.1	2	.1	35.5	37	.2	.3	.25	1	.5	.6	.03	9.1	11	.06	.09	.06	.5	.1	-	-	-	-	-	-	-	-	-	-	-	-	-	-			

Subtensions measured at the highest magnification for mrad and MOA reticles. Dimensions measured in inches. Dual Use: Shooting Tactical / Hunting

RIFLESCOPE DIMENSIONS

MODEL	LENGTHS						HEIGHTS	
	L1	L2	L3	L4	L5	L6	H1	H2
1-6 x 24	10.1"	2.8"	1.5"	5.9"	.6"	3.6"	1.29"	1.81"
3-18 x 50 FFP	14.4"	2.0"	2.2"	6.1"	4.1"	4.1"	2.32"	1.81"
4.5-27 x 56 FFP	14.4"	2.0"	2.2"	6.1"	4.1"	4.1"	2.55"	1.81"

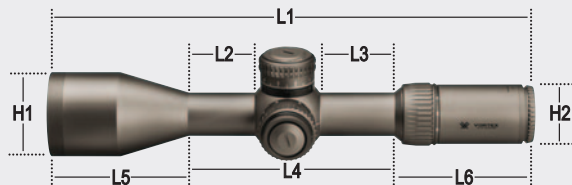

RAZOR® HD > FIRST FOCAL PLANE

RIFLESCOPE AND RETICLE SPECIFICATIONS

RAZOR HD EBR-1 MOA RETICLE

Hashmarked ranging reticle using MOA based subtension lines for ranging, holdover, and windage corrections.

Letters refer to reticle subtensions listed in chart below.

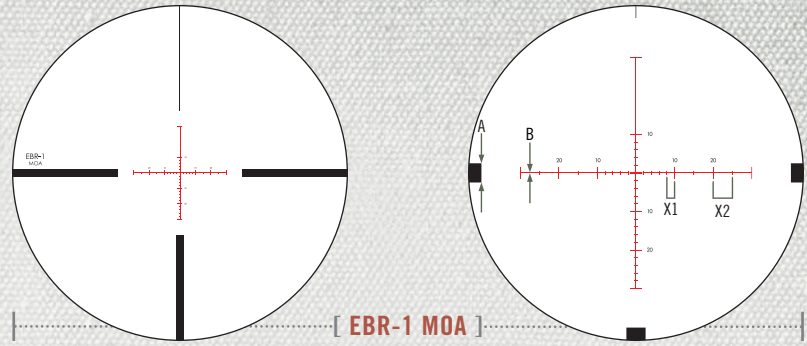

RAZOR HD EBR-3 MRAD RETICLE

Hashmarked ranging reticle using MRAD based subtension lines for ranging, holdover, and windage corrections.

Letters refer to reticle subtensions listed in chart below.

Note: Reticle images shown for representation only. Reticle image varies between scope models depending on magnification and reticle plane.

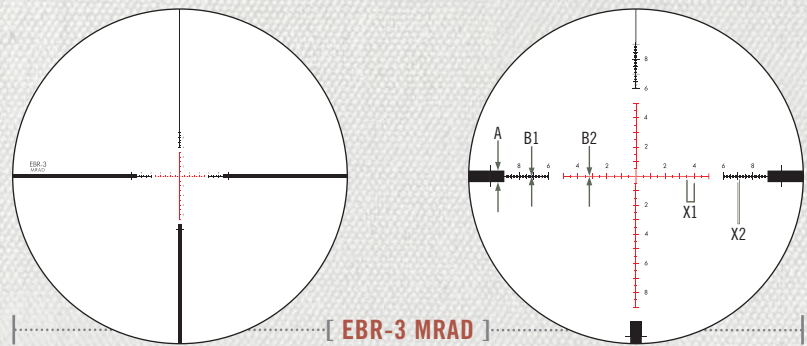

VISIT WWW.VORTEXTACTICAL.COM for specific combinations of reticles and riflescopes.

RAZOR HD RIFLESCOPES

MAGNIFICATION x OBJECTIVE LENS	RETICLE STYLE	WEIGHT	EYE RELIEF	FIELD OF VIEW (100 YARDS)	TUBE SIZE	WATERPROOF FOGPROOF	LENS COATINGS	FINISH	ADJUSTMENT GRADUATION	ELEVATION ADJUSTMENT	WINDAGE ADJUSTMENT	TRAVEL PER ROTATION	TURRET STYLE	PARALLAX (YARDS)	VIP WARRANTY
5-20 x 50 FFP	EBR-1 MOA	35.2 oz	3.9"	22.0 - 5.76'	35mm	Argon Gas	XR FMC	Stealth Shadow	1/4 MOA	125 MOA	125 MOA	15 MOA	Tactical	40 to Infinity	✓
5-20 x 50 FFP	EBR-1 MOA	35.2 oz	3.9"	22.0 - 5.76'	35mm	Argon Gas	XR FMC	Stealth Shadow	1/4 MOA	125 MOA	125 MOA	25 MOA	Tactical	40 to Infinity	✓
5-20 x 50 FFP	EBR-2B MOA	35.2 oz	3.9"	22.0 - 5.76'	35mm	Argon Gas	XR FMC	Stealth Shadow	1/4 MOA	125 MOA	125 MOA	25 MOA	Tactical	40 to Infinity	✓
5-20 x 50 FFP	EBR-2B MRAD	35.2 oz	3.9"	22.0 - 5.76'	35mm	Argon Gas	XR FMC	Stealth Shadow	.1 MRAD	36 MRAD	36 MRAD	5 MRAD	Tactical	40 to Infinity	✓
5-20 x 50 FFP	EBR-2B MRAD	35.2 oz	3.9"	22.0 - 5.76'	35mm	Argon Gas	XR FMC	Stealth Shadow	.1 MRAD	36 MRAD	36 MRAD	10 MRAD	Tactical	40 to Infinity	✓
5-20 x 50 FFP	EBR-3 MRAD	35.2 oz	3.9"	22.0 - 5.76'	35mm	Argon Gas	XR FMC	Stealth Shadow	.1 MRAD	36 MRAD	36 MRAD	5 MRAD	Tactical	40 to Infinity	✓
5-20 x 50 FFP	EBR-3 MRAD	35.2 oz	3.9"	22.0 - 5.76'	35mm	Argon Gas	XR FMC	Stealth Shadow	.1 MRAD	36 MRAD	36 MRAD	10 MRAD	Tactical	40 to Infinity	✓

[RETICLE SUBTENSIONS]

MODEL	EBR-1 MOA				EBR-2B MOA					EBR-2B MRAD						EBR-3 MRAD						
	A	B	X1	X2	A	B	D1	D2	S	X1	A	B	D1	D2	S	X1	X2	A	B1	B2	X1	X2
5-20 x 50 FFP	5	.2	2	5	3	.15	.2	.3	.25	1	.8	.06	.06	.09	.07	.5	.2	.8	.03	.05	.5	.1

Subtensions measured at the highest magnification for mrad and MOA reticles. Dimensions measured in inches. **Dual Use: Shooting Tactical / Hunting**

RIFLESCOPE DIMENSIONS

MODEL	LENGTHS						HEIGHTS	
	L1	L2	L3	L4	L5	L6	H1	H2
5-20 x 50 FFP	15.8"	2.5"	2.9"	6.9"	4.0"	4.9"	2.33"	1.74"

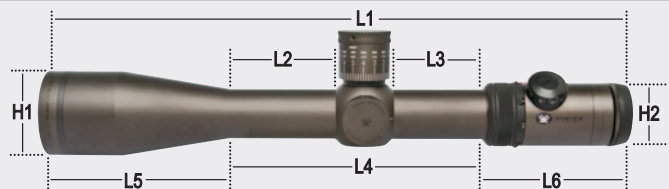

RAZOR® HD > FIRST FOCAL PLANE

RIFLESCOPE AND RETICLE SPECIFICATIONS

RAZOR HD EBR-2B MOA and MRAD RETICLE

Hashmarked ranging reticle using MOA or MRAD based subtension lines for ranging, holdover, and windage corrections. Includes windage reference dots on drop lines.

Letters refer to reticle subtensions listed in chart on previous page.

Note: Reticle images shown for representation only. Reticle image varies between scope models depending on magnification and reticle plane.

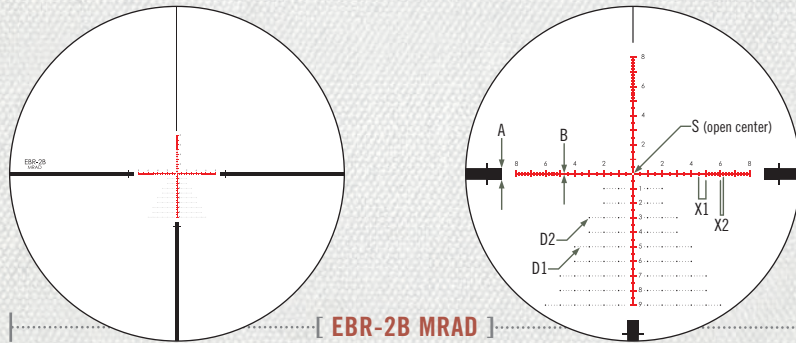
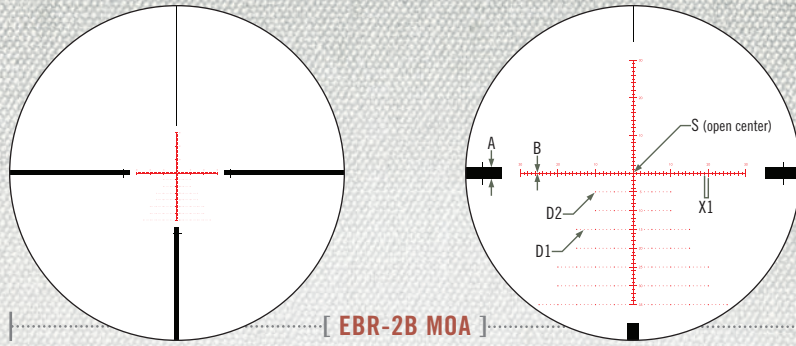

VISIT WWW.VORTEXTACTICAL.COM for specific combinations of reticles and riflescopes.

HOW TO RANGE WITH MRAD AND MOA RETICLES

Using simple formulas, both MOA and mrad hashmarked reticles can be used to estimate distance. This is a useful skill, and provides a good back-up should your laser rangefinder fail or lose battery power. To range with a reticle formula, you can use either the vertical or horizontal scale. Place the reticle on a target of known width or height and read the number of mrad or MOAs spanned. You will obtain maximum accuracy in ranging by calculating as exact a measurement as possible, down to fractions of an mrad or MOA. Accurate measuring will depend on a very steady hold. The rifle should be solidly braced using a rest, bipod or sling when measuring the size of the target or nearby object. Once you have an accurate reading, use a formula to calculate the distance.

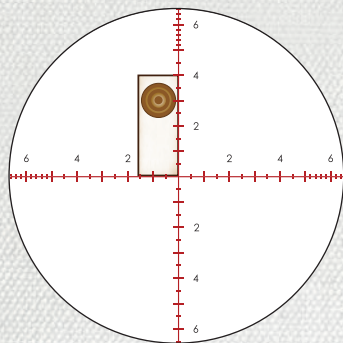

MRAD RANGING FORMULAS

$$\frac{\text{Target's Known Width or Height in Yards} \times 1000}{\text{Target's Width or Height in mrad as Measured on Reticle}} = \text{Range in Yards}$$

$$\frac{\text{Target's Known Width or Height in Meters} \times 1000}{\text{Target's Width or Height in mrad as Measured on Reticle}} = \text{Range in Meters}$$

$$\frac{\text{Target's Known Width or Height in Inches} \times 27.8}{\text{Target's Width or Height in mrad as Measured on Reticle}} = \text{Range in Yards}$$

Mrad Example: Ranging a 6-foot target stand (2 yards) at 4 mrad to get 500 yards.

$$\frac{2 \times 1000}{4 \text{ mrad}} = 500 \text{ Yards}$$

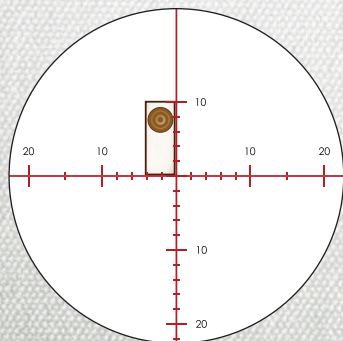

MOA RANGING FORMULA

$$\frac{\text{Target's Known Width or Height in Inches} \times 95.5}{\text{Target's Width or Height in MOAs as Measured on Reticle}} = \text{Range in Yards}$$

Note: In the MOA ranging formula, a shooter may substitute 100 for 95.5 in the interest of speedier calculations. Be aware that this will produce a five percent over-estimation error of the yardage distance obtained.

MOA Example: Ranging a 6-foot target stand (72 inches) at 10 MOAs yields 688 yards.

$$\frac{72 \times 95.5}{10 \text{ MOA}} = 688 \text{ Yards}$$

VIPER® PST™

RIFLESCOPE AND RETICLE SPECIFICATIONS

VIPER PST EBR-1 MOA and MRAD RETICLE

Designed to maximize long distance shooting and ranging abilities, the hashmarked EBR-1 ranging reticle uses MOA or MRAD based subtension lines for ranging, holdover, and windage corrections.

Letters refer to reticle subtensions listed in chart below.

Note: Reticle images shown for representation only. Reticle image varies between scope models depending on magnification and reticle plane.

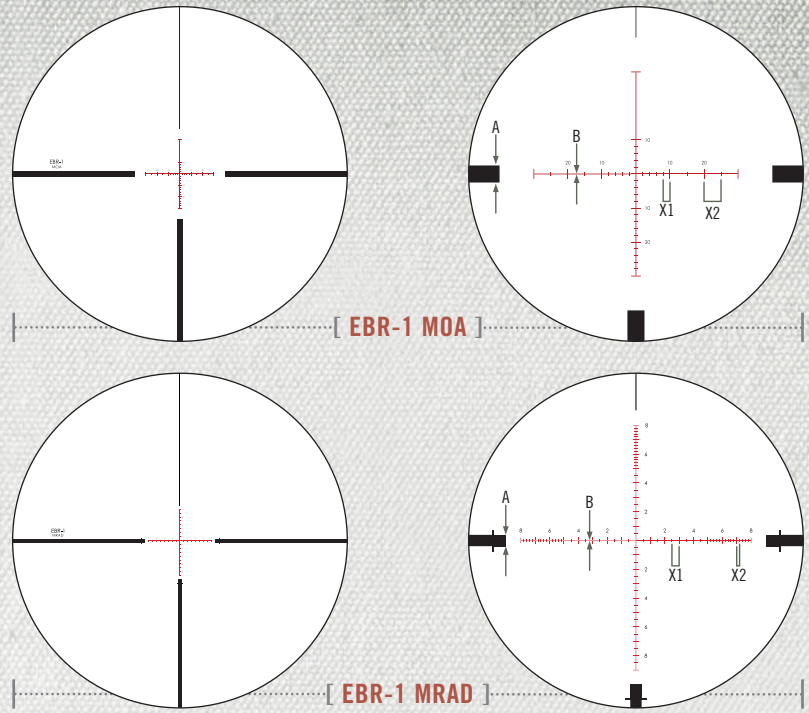

VISIT WWW.VORTEXTACTICAL.COM for specific combinations of reticles and riflescopes.

VIPER PST RIFLESCOPES

MAGNIFICATION x OBJECTIVE LENS	RETICLE STYLE	WEIGHT	EYE RELIEF	FIELD OF VIEW (100 YARDS)	TUBE SIZE	WATERPROOF FOGPROOF	LENS COATINGS	FINISH	ADJUSTMENT GRADUATION	ELEVATION ADJUSTMENT	WINDAGE ADJUSTMENT	TRAVEL PER ROTATION	TURRET STYLE	PARALLAX (YARDS)	VIP WARRANTY
1-4 x 24	TMCQ MOA	14.4 oz	4.0"	98.0 - 27.5'	30mm	Argon Gas	XR FMC	Black Matte	1/2 MOA	90 MOA	90 MOA	24 MOA	Low Capped	100	✓
1-4 x 24	TMCQ MOA	16.2 oz	4.0"	98.0 - 27.5'	30mm	Argon Gas	XR FMC	Black Matte	1/2 MOA	220 MOA	220 MOA	24 MOA	Tactical	100	✓
1-4 x 24	TMCQ MRAD	16.2 oz	4.0"	98.0 - 27.5'	30mm	Argon Gas	XR FMC	Black Matte	.2 MRAD	64 MRAD	64 MRAD	10 MRAD	Tactical	100	✓
2.5-10 x 44	EBR-1 MOA	18.8 oz	4.0"	47.0 - 10.9'	30mm	Argon Gas	XR FMC	Black Matte	1/4 MOA	86 MOA	86 MOA	12 MOA	Tactical	100	✓
2.5-10 x 44	EBR-1 MRAD	18.8 oz	4.0"	47.0 - 10.9'	30mm	Argon Gas	XR FMC	Black Matte	.1 MRAD	25 MRAD	25 MRAD	5 MRAD	Tactical	100	✓
4-16 x 50	EBR-1 MOA	22.4 oz	4.0"	27.4 - 7.4'	30mm	Argon Gas	XR FMC	Black Matte	1/4 MOA	75 MOA	75 MOA	12 MOA	Tactical	50 to Infinity	✓
4-16 x 50	EBR-1 MRAD	22.4 oz	4.0"	27.4 - 7.4'	30mm	Argon Gas	XR FMC	Black Matte	.1 MRAD	21 MRAD	21 MRAD	5 MRAD	Tactical	50 to Infinity	✓
6-24 x 50	EBR-1 MOA	23.4 oz	4.0"	17.8 - 5.1'	30mm	Argon Gas	XR FMC	Black Matte	1/4 MOA	65 MOA	65 MOA	12 MOA	Tactical	50 to Infinity	✓
6-24 x 50	EBR-1 MRAD	23.4 oz	4.0"	17.8 - 5.1'	30mm	Argon Gas	XR FMC	Black Matte	.1 MRAD	19 MRAD	19 MRAD	5 MRAD	Tactical	50 to Infinity	✓
2.5-10 x 32 FFP	EBR-1 MOA	18.7 oz	4.0"	47.0 - 10.9'	30mm	Argon Gas	XR FMC	Black Matte	1/4 MOA	86 MOA	86 MOA	12 MOA	Tactical	35 to Infinity	✓
2.5-10 x 32 FFP	EBR-1 MRAD	18.7 oz	4.0"	47.0 - 10.9'	30mm	Argon Gas	XR FMC	Black Matte	.1 MRAD	25 MRAD	25 MRAD	5 MRAD	Tactical	35 to Infinity	✓
4-16 x 50 FFP	EBR-1 MOA	22.4 oz	4.0"	27.4 - 7.4'	30mm	Argon Gas	XR FMC	Black Matte	1/4 MOA	75 MOA	75 MOA	12 MOA	Tactical	50 to Infinity	✓
4-16 x 50 FFP	EBR-1 MRAD	22.4 oz	4.0"	27.4 - 7.4'	30mm	Argon Gas	XR FMC	Black Matte	.1 MRAD	21 MRAD	21 MRAD	5 MRAD	Tactical	50 to Infinity	✓
6-24 x 50 FFP	EBR-1 MOA	23.4 oz	4.0"	17.8 - 5.1'	30mm	Argon Gas	XR FMC	Black Matte	1/4 MOA	65 MOA	65 MOA	12 MOA	Tactical	50 to Infinity	✓
6-24 x 50 FFP	EBR-1 MRAD	23.4 oz	4.0"	17.8 - 5.1'	30mm	Argon Gas	XR FMC	Black Matte	.1 MRAD	19 MRAD	19 MRAD	5 MRAD	Tactical	50 to Infinity	✓
* 6-24 x 50 FFP	EBR-2C MOA	23.4 oz	4.0"	17.8 - 5.1'	30mm	Argon Gas	XR FMC	Black Matte	1/4 MOA	65 MOA	65 MOA	12 MOA	Tactical	50 to Infinity	✓
* 6-24 x 50 FFP	EBR-2C MRAD	23.4 oz	4.0"	17.8 - 5.1'	30mm	Argon Gas	XR FMC	Black Matte	.1 MRAD	19 MRAD	19 MRAD	5 MRAD	Tactical	50 to Infinity	✓

* New Model for 2014

[RETICLE SUBTENSIONS]

MODEL	EBR-1 MRAD				EBR-1 MOA				EBR-2C MRAD								EBR-2C MOA								TMCQ MRAD					TMCQ MOA							
	A	B	X1	X2	A	B	X1	X2	A	B	C1	C2	D1	D2	S	X1	X2	A	B	C1	C2	D1	D2	S	X1	X2	B	D	J1	J2	X1	B	D	J1	J2	X1	
1-4 x 24	-	-	-	-	-	-	-	-	-	-	-	-	-	-	-	-	-	-	-	-	-	-	-	-	-	-	-	.06	.3	5	6.5	.5	.2	1	18	22	2
2.5-10 x 44	.75	.04	.5	1	2.5	.15	2	5	-	-	-	-	-	-	-	-	-	-	-	-	-	-	-	-	-	-	-	-	-	-	-	-	-	-	-	-	
4-16 x 50	.5	.03	.5	1	1.5	.1	2	5	-	-	-	-	-	-	-	-	-	-	-	-	-	-	-	-	-	-	-	-	-	-	-	-	-	-	-	-	
6-24 x 50	.3	.02	.2	.5	1	.06	1	2.5	-	-	-	-	-	-	-	-	-	-	-	-	-	-	-	-	-	-	-	-	-	-	-	-	-	-	-	-	
2.5-10 x 32 FFP	.5	.06	.5	.2	5	.2	2	5	-	-	-	-	-	-	-	-	-	-	-	-	-	-	-	-	-	-	-	-	-	-	-	-	-	-	-	-	
4-16 x 50 FFP	.8	.06	.5	.2	5	.21	2	5	-	-	-	-	-	-	-	-	-	-	-	-	-	-	-	-	-	-	-	-	-	-	-	-	-	-	-	-	
6-24 x 50 FFP	.65	.04	.5	.2	3	.18	2	5	.6	.03	9	11	.06	.09	.06	.5	.1	2	.1	36.5	38	.2	.3	.25	2	.5	-	-	-	-	-	-	-	-	-	-	

Subtensions measured at the highest magnification for mrad and MOA reticles. Dimensions measured in inches. Dual Use: Shooting Tactical / Hunting

RIFLESCOPE DIMENSIONS

MODEL	LENGTHS						HEIGHTS	
	L1	L2	L3	L4	L5	L6	H1	H2
1-4 x 24	9.7"	2.5"	2.2"	6.0"	n/a	3.6"	1.18"	1.63"
2.5-10 x 44	12.0"	2.1"	2.3"	5.6"	2.8"	3.6"	2.03"	1.63"
4-16 x 50	13.7"	2.1"	2.2"	5.6"	4.2"	3.6"	2.26"	1.63"
6-24 x 50	15.5"	2.5"	2.2"	6.0"	5.8"	3.6"	2.26"	1.63"
2.5-10 x 32 FFP	12.8"	2.3"	2.2"	5.9"	3.3"	3.6"	1.55"	1.63"
4-16 x 50 FFP	13.7"	2.1"	2.2"	5.6"	4.2"	3.6"	2.26"	1.63"
6-24 x 50 FFP	15.5"	2.5"	2.2"	6.0"	5.8"	3.6"	2.26"	1.63"

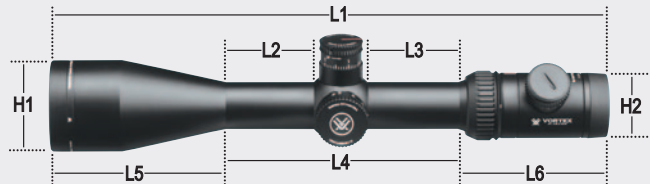

VIPER PST EBR-2C MOA and MRAD RETICLE

Hashmarked ranging reticle using MOA or MRAD based subtension lines for ranging, holdover, and windage corrections. Includes windage reference dots on drop lines.

Letters refer to reticle subtensions listed in chart on previous page.

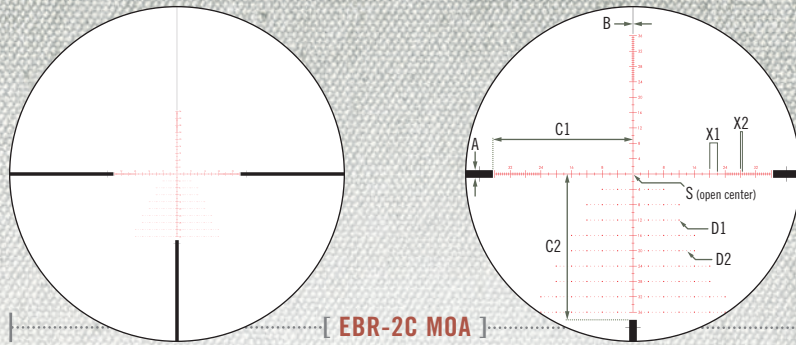

[EBR-2C MOA]

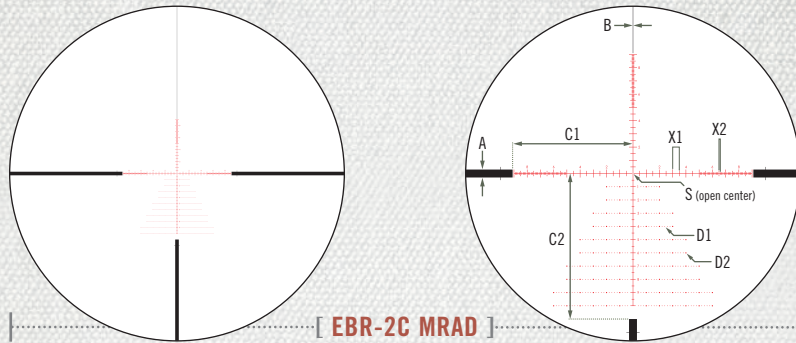

[EBR-2C MRAD]

VIPER PST TMCQ MOA and MRAD RETICLE

Hybrid reticle using combination of illuminated dot and MOA or MRAD based subtension hashmarks. Designed for rapid close and mid-range shooting as well as ranging.

Letters refer to reticle subtensions listed in chart on previous page.

Note: Reticle images shown for representation only. Reticle image varies between scope models depending on magnification and reticle plane.

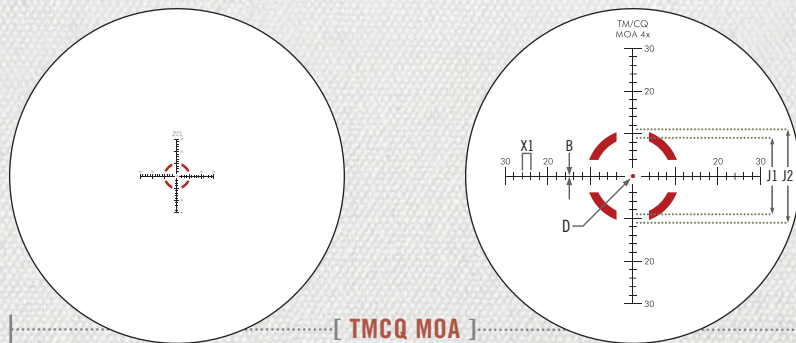

[TMCQ MOA]

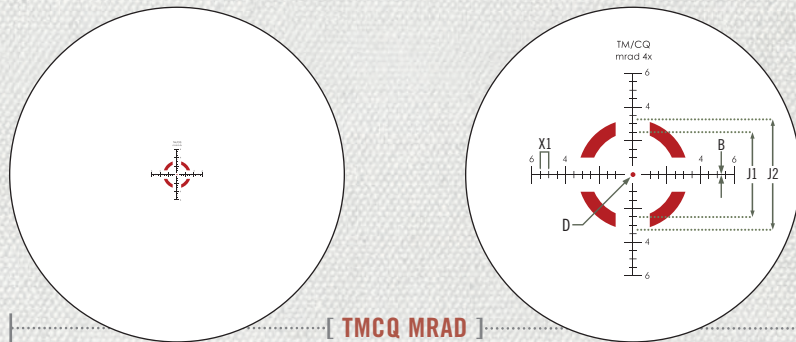

[TMCQ MRAD]

VISIT WWW.VORTEXTACTICAL.COM for specific combinations of reticles and riflescopes.

FIRST FOCAL PLANE VERSUS SECOND FOCAL PLANE RIFLESCOPES

All rifle scope reticles can be termed either first focal plane (FFP) or second focal plane (SFP) depending upon their internal location within the rifle scope. FFP reticles are located in the front of the erector tube near the windage and elevation turrets; SFP reticles are located in the eyepiece assembly.

First Focal Plane Reticles (FFP)

This style of reticle will appear to grow or shrink in size as the magnification changes; reticle details appear heavier at higher magnifications and finer at lower magnifications. The main advantage of an FFP reticle is that the reticle subtensions used for ranging, holdover, and wind drift correction are consistent at all magnifications.

Second Focal Plane Reticles (SFP)

This style of reticle will not change in size as the magnification changes. The advantage of a SFP reticle is that the reticle maintains the same appearance at all magnifications. Reticle subtensions used for ranging, holdover and wind correction are only valid at a single magnification—generally the highest.

VIPER[®] HS-T[™] RIFLESCOPE AND RETICLE SPECIFICATIONS

VIPER HS-T VMR-1 MOA and MRAD RETICLE

Hashmarked ranging reticle using MOA or MRAD based subtension lines for ranging, holdover, and windage corrections.

Letters refer to reticle subtensions listed in chart below.

Note: Reticle images shown for representation only. Reticle image varies between scope models depending on magnification and reticle plane.

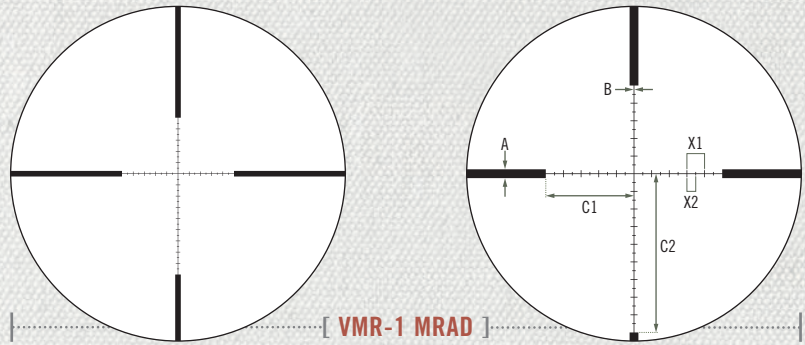
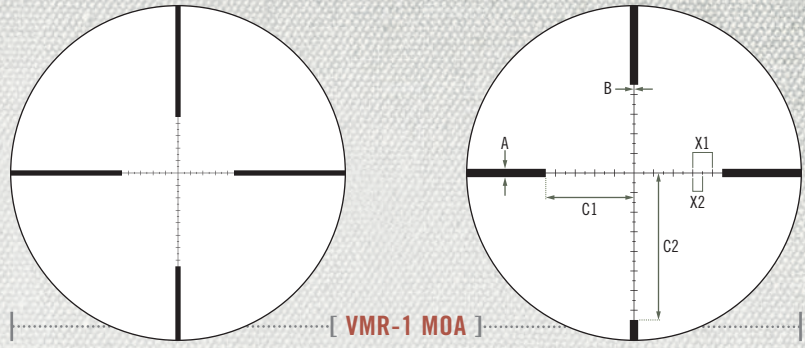

VISIT WWW.VORTEXTACTICAL.COM for specific combinations of reticles and riflescopes.

VIPER HS-T RIFLESCOPES

MAGNIFICATION x OBJECTIVE LENS	RETICLE STYLE	WEIGHT	EYE RELIEF	FIELD OF VIEW (100 YARDS)	TUBE SIZE	WATERPROOF FOGPROOF	LENS COATINGS	FINISH	ADJUSTMENT GRADUATION	ELEVATION ADJUSTMENT	WINDAGE ADJUSTMENT	TRAVEL PER ROTATION	TURRET STYLE	PARALLAX (YARDS)	VIP WARRANTY
* 4-16 x 44	VMR-1 MOA	20.8 oz	4.0"	27.4. - 7.4'	30mm	Argon Gas	XR FMC	Black Matte	1/4 MOA	75 MOA	75 MOA	12 MOA	Tactical	50 to Infinity	✓
* 4-16 x 44	VMR-1 MRAD	20.8 oz	4.0"	27.4. - 7.4'	30mm	Argon Gas	XR FMC	Black Matte	.1 MRAD	21 MRAD	21 MRAD	5 MRAD	Tactical	50 to Infinity	✓
* 6-24 x 50	VMR-1 MOA	22.6 oz	4.0"	17.8 - 5.1'	30mm	Argon Gas	XR FMC	Black Matte	1/4 MOA	65 MOA	65 MOA	12 MOA	Tactical	50 to Infinity	✓
* 6-24 x 50	VMR-1 MRAD	22.6 oz	4.0"	17.8 - 5.1'	30mm	Argon Gas	XR FMC	Black Matte	.1 MRAD	19 MRAD	19 MRAD	5 MRAD	Tactical	50 to Infinity	✓

* New Model for 2014

[RETICLE SUBTENSIONS]

MODEL	VMR-1 MOA						VMR-1 MRAD					
	A	B	C1	C2	X1	X2	A	B	C1	C2	X1	X2
4-16 x 44	1.7	.15	18	30	4	2	.5	.05	5	9	1	.5
6-24 x 50	1.7	.15	18	30	4	2	.5	.05	5	9	1	.5

Subtensions measured at the highest magnification for mrad and MOA reticles (18x for 6-24x50 models). Dimensions measured in inches. **Dual Use: Shooting Tactical / Hunting**

RIFLESCOPE DIMENSIONS

MODEL	LENGTHS						HEIGHTS	
	L1	L2	L3	L4	L5	L6	H1	H2
4-16 x 44	13.7"	2.0"	2.2"	5.6"	4.2"	3.6"	2.03"	1.63"
6-24 x 50	15.5"	2.5"	2.2"	6.0"	5.8"	3.6"	2.26"	1.63"

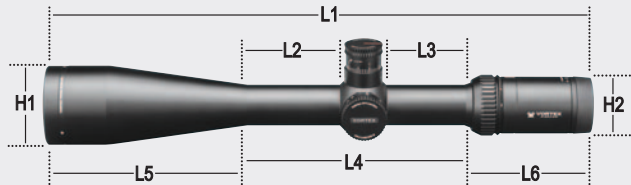

SPITFIRE™ PRISM SCOPE AND RETICLE SPECIFICATIONS

SPITFIRE 1X DRT MOA RETICLE

New for 2014, the DRT (Dual Ring Tactical) reticle is designed for rapid shooting at close distances. The dual ring design pulls the eye into instant alignment with the reticle center and target.

Letters refer to reticle subtensions listed in chart below.

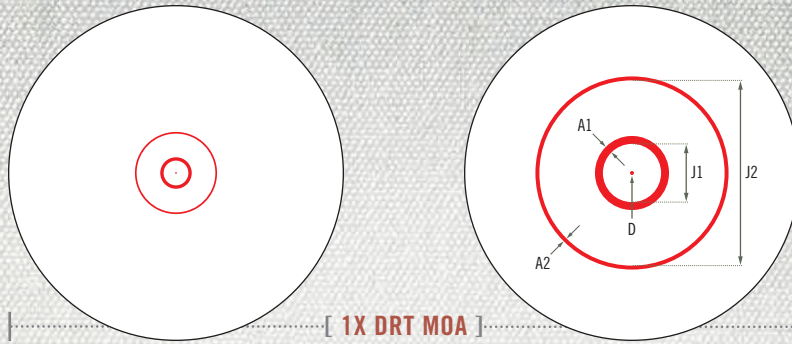

SPITFIRE 3X EBR-556B MOA RETICLE

New for 2014, the EBR-556B is a BDC reticle designed around the 5.56 x 45 cartridge. Reticle will aid in rapid shooting at both near and far ranges. Provides holdover and ranging references from 0-500 yards.

Letters refer to reticle subtensions listed in chart below.

Note: Reticle images shown for representation only.

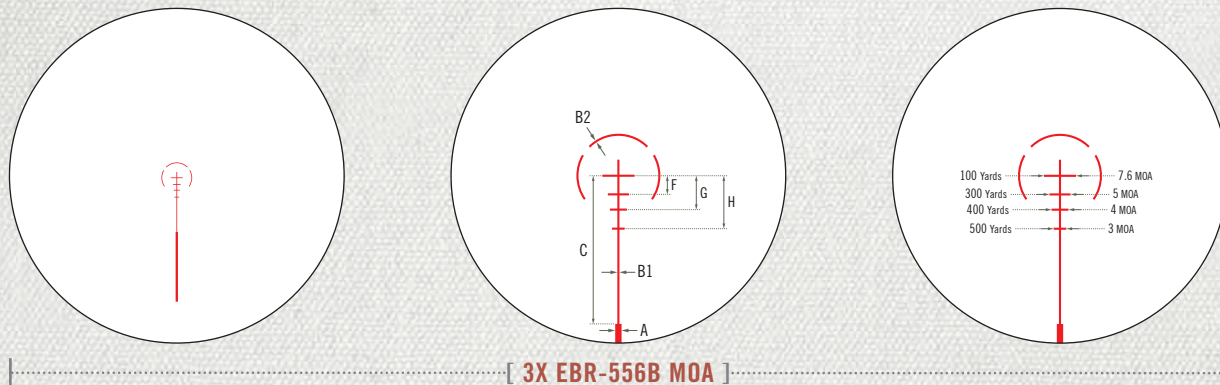

VISIT WWW.VORTEXTACTICAL.COM for specific combinations of reticles and riflescopes.

SPITFIRE PRISM SCOPES

MAGNIFICATION	RETICLE STYLE	WEIGHT	EYE RELIEF	FIELD OF VIEW (100 YARDS)	LENS DIAMETER	WATERPROOF	LENS COATING	FINISH	ADJUSTMENT GRADUATION	ELEVATION ADJUSTMENT	WINDAGE ADJUSTMENT	PARALLAX SETTING	VIP WARRANTY
* 1x	DRT MOA	8.7 oz	3.7"	75.0'	20mm	Yes	XR FMC	Black Matte	1 MOA per click	120 MOA	120 MOA	Parallax Free	✓
* 3x	EBR-556B MOA	12.2 oz	2.8"	31.5'	32mm	Yes	XR FMC	Black Matte	1/2 MOA per click	120 MOA	120 MOA	100 yards	✓

* New Model for 2014 **Dual Use: Shooting Tactical / Hunting**

[RETICLE SUBTENSIONS]

MODEL	DRT MOA					EBR-556B MOA							
	A1	A2	D	J1	J2	A	B1	B2	C	F	G	H	
1x	6	3	3	44	140	-	-	-	-	-	-	-	
3x	-	-	-	-	-	1.5	.5	.5	35	4.4	8	12.5	

Subtensions measured at the highest magnification for MOA reticles. Dimensions measured in inches. **Dual Use: Shooting Tactical / Hunting**



HD™ (High Density) premium extra-low dispersion glass delivers the ultimate in resolution and color fidelity, resulting in High Definition images.



XR Plus™ premium fully multi-coated lenses deliver the highest level of light transmission for maximum brightness.



Highly prized argon gas purging for superior fogproof and waterproof performance.



XD™ extra-low dispersion glass increases resolution and color fidelity, resulting in crisp, sharp images.



XR™ anti-reflective coatings deliver incredible image detail with extremely high resolution and light transmission.



Neutral pressure nitrogen purging guarantees waterproofing and fogproofing that withstands the elements at any elevation.



ArmorTek™ repels the oil and corrosive salts of fingerprints from lenses. This ultra-hard lens armor is chemically bonded to outer glass elements, providing a scratch-resistant, stain-proof surface. ArmorTek protects optical glass from dust, dirt and smudges.



Waterproof performance designed to withstand harsh weather conditions.

RED DOT SPECIFICATIONS



RAZOR RED DOT

MAGNIFICATION	DOT COLOR	WEIGHT	EYE RELIEF	DOT SIZE	WATERPROOF	LENS COATING	FINISH	ADJUSTMENT GRADUATION	ELEVATION ADJUSTMENT	WINDAGE ADJUSTMENT	PARALLAX SETTING	VIP WARRANTY
1x	Bright Red	1.4 oz	Unlimited	3 MOA	Yes	XR FMC	Black Matte	1 MOA	170 MOA	114 MOA	Parallax Free	✓
1x	Bright Red	1.4 oz	Unlimited	6 MOA	Yes	XR FMC	Black Matte	1 MOA	170 MOA	114 MOA	Parallax Free	✓

* New Model for 2014 **Dual Use: Shooting Tactical / Hunting**



SPARC II RED DOT

MAGNIFICATION	DOT COLOR	WEIGHT	EYE RELIEF	DOT SIZE	WATERPROOF FOGPROOF	LENS COATING	FINISH	ADJUSTMENT GRADUATION	ELEVATION ADJUSTMENT	WINDAGE ADJUSTMENT	PARALLAX SETTING	VIP WARRANTY
* 1x	Bright Red	5.9 oz	Unlimited	2 MOA	Nitrogen Gas	FMC	Black Matte	1 MOA per click; 45 MOA per rotation	90 MOA	90 MOA	Parallax Free	✓

* New Model for 2014 **Dual Use: Shooting Tactical / Hunting**



STRIKEFIRE II RED DOT

MAGNIFICATION	DOT COLOR	WEIGHT	EYE RELIEF	DOT SIZE	TUBE SIZE	WATERPROOF FOGPROOF	LENS COATING	FINISH	ADJUSTMENT GRADUATION	ELEVATION ADJUSTMENT	WINDAGE ADJUSTMENT	PARALLAX SETTING	VIP WARRANTY
* 1x - 40mm (Lower 1/3 Co-Witness)	Red / Green	7.2 oz	Unlimited	4 MOA	30mm	Nitrogen Gas	FMC	Black Matte	1/2 MOA per click; 25 MOA per rotation	100 MOA	100 MOA	Parallax Free	✓
* 1x - 40mm (Lower 1/3 Co-Witness)	Bright Red	7.2 oz	Unlimited	4 MOA	30mm	Nitrogen Gas	FMC	Black Matte	1/2 MOA per click; 25 MOA per rotation	100 MOA	100 MOA	Parallax Free	✓
* 1x - 21mm (Low Ring Mount)	Red / Green	7.2 oz	Unlimited	4 MOA	30mm	Nitrogen Gas	FMC	Black Matte	1/2 MOA per click; 25 MOA per rotation	100 MOA	100 MOA	Parallax Free	✓

* New Model for 2014 **Dual Use: Shooting Tactical / Hunting**

RANGEFINDER SPECIFICATIONS



RANGER 1000 RANGEFINDER

MAGNIFICATION	OBJECTIVE LENS	WEIGHT	MINIMUM RANGE	MAXIMUM RANGE	EYE RELIEF	FIELD OF VIEW (1000 YARDS)	FIELD OF VIEW ANGULAR	WATERPROOF	LENS COATING	EYECUP STYLE	VIP WARRANTY
6x	22mm	7.7 oz	11 yards	1000 yards	17mm	315'	6.0°	✓	FMC	Fold	✓

MONOCULAR SPECIFICATIONS



RECON R/T

SOLO R/T

	RECON R/T	SOLO R/T
Monoculars	15 x 50	10 x 50
Magnification	15x	10x
Objective Lens	50mm	50mm
Weight	15.2 oz	15.2 oz
Length	7.0"	7.0"
Close Focus	12.0'	12.0'
Field of View (1000 yards)	215'	280'
Angular Field of View	4.1°	5.3°
Eye Relief	16.0mm	19.5mm
Eyecup Style	Fold-down	Fold-down
Waterproof	✓	✓
FogProof (Gas Purged)	Argon	Argon
ArmorTek	✓	-
XD Glass	✓	-
Lens Coatings	XR FMC	XR FMC
VIP Unconditional Warranty	✓	✓

VORTEX RANGING R/T RETICLE

Ranging reticle for the Recon R/T scopes, Solo R/T monocular and Viper HD R/T binoculars using mrad-based subtensions. Includes silhouettes for quick ranging.

US Patent 7,877,886

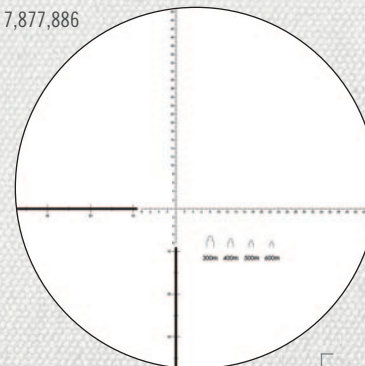

Quick ranging silhouettes.



31" / 79cm

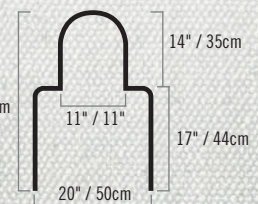

BINOCULAR SPECIFICATIONS



[BINOCULARS]

	RAZOR HD				KAIBAB HD		VIPER HD R/T
	12x50	10x50	10x42	8x42	20x56	15x56	10x50
Magnification	12x	10x	10x	8x	20x	15x	10x
Objective Lens	50mm	50mm	42mm	42mm	56mm	56mm	50mm
Weight	28.7 oz	28.1 oz	24.8 oz	24.2 oz	43.6 oz	43.9 oz	27.2 oz
Height x Width	6.8 x 5.1"	6.8 x 5.1"	5.9 x 5.1"	5.9 x 5.1"	7.7 x 5.7"	7.7 x 5.7"	6.7 x 5.2"
Close Focus	10.0'	10.0'	6.0'	6.0'	23.0'	23.0'	8.2'
Field of View (1000 yards)	285'	315'	362'	388'	168'	215'	278'
Angular Field of View	5.4°	6.0°	6.9°	7.4°	3.2°	4.1°	5.3°
Eye Relief	15.5mm	16.5mm	16.5mm	17.5mm	15.0mm	15.0mm	20.0mm
Eyecup Style	Twist	Twist	Twist	Twist	Twist	Twist	Fold
Interpupillary Distance	57-74mm	57-74mm	55-75mm	55-75mm	60-76mm	60-76mm	59-75mm
Waterproof	✓	✓	✓	✓	✓	✓	✓
FogProof (Gas Purged)	Argon	Argon	Argon	Argon	Argon	Argon	Argon
ArmorTek	✓	✓	✓	✓	✓	✓	✓
HD / XD Glass	HD Premium - APO	HD Premium - APO	HD Premium - APO	HD Premium - APO	HD Premium - APO	HD Premium - APO	HD
Lens Coatings	XRPlus	XRPlus	XRPlus	XRPlus	XRPlus	XRPlus	XR FMC
Prism Coatings	Dielectric	Dielectric	Dielectric	Dielectric	Dielectric	Dielectric	-
Phase Corrected	✓	✓	✓	✓	✓	✓	✓
Locking Diopter	✓	✓	✓	✓	✓	✓	-
Tripod Adaptable	✓	✓	✓	✓	✓	✓	✓
VIP Unconditional Warranty	✓	✓	✓	✓	✓	✓	✓



[BINOCULARS]

	VIPER R/T	HURRICANE
	8x28	10x50
Magnification	8x	10x
Objective Lens	28mm	50mm
Weight	11.8 oz	38.4 oz
Height x Width	4.7 x 4.5"	7.4 x 8.0"
Close Focus	7.5'	30.0'
Field of View (1000 yards)	319'	341'
Angular Field of View	6.1°	6.5°
Eye Relief	20.0mm	15.0mm
Eyecup Style	Fold	Fold
Interpupillary Distance	56-73mm	56-74mm
Waterproof	✓	✓
FogProof (Gas Purged)	Argon	Argon
ArmorTek	✓	✓
HD / XD Glass	XD	-
Lens Coatings	XR FMC	FMC
Prism Coatings	-	-
Phase Corrected	✓	N/A
Locking Diopter	✓	-
Tripod Adaptable	✓	✓
VIP Unconditional Warranty	✓	✓

SPOTTING SCOPE

SPECIFICATIONS

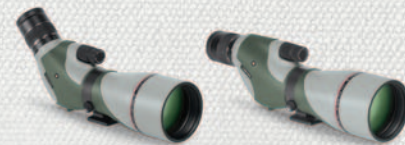

[SPOTTING SCOPES]

	RAZOR HD	
	20-60 x 85 HD	20-60 x 85 HD
Spotting Scopes	20-60 x 85 HD	20-60 x 85 HD
Eyepiece Position	Angled	Straight
Magnification	20-60x	20-60x
Objective Lens	85mm	85mm
Weight	65.7 oz	65.7 oz
Length	15.3"	15.8"
Close Focus	16.4'	16.4'
Field of View (1000 yards)	117-60'	117-60'
Angular Field of View	2.2-1.1°	2.2-1.1°
Eye Relief	18-20mm	18-20mm
Eyecup Style	Twist	Twist
Waterproof	✓	✓
FogProof (Gas Purged)	Argon Gas	Argon Gas
HD / XD Glass	HD Premium	HD Premium
ArmorTek	✓	✓
Lens Coatings	XRPlus	XRPlus
Prism Coatings	Dielectric	Dielectric
VIP Unconditional Warranty	✓	✓

ArmorTek, Binoc-Loc, Copperhead, Crossfire, Dead-Hold, Diamondback, Fury, Golden Eagle, Hurricane, Impact, Kaibab, LRBC, Ranger, Razor, Recon, Solo, SPARC, Strike Eagle, Strike Fire, Strike Force, Talon, The Force of Optics, Twister, Typhoon, VTX logo, V-Brite, Vanquish, Venom, Versa-Plex C3, Viper, Vortex, and Vulture are registered trademarks of Vortex Optics.

CBX, Escape, Firestorm, GlassPAK, High Country, HS, Lightning, L-TEC, Nomad, PST, Pro GT, RT45, Raptor, Ridgeview, Skyline, Spitfire, STX, Summit, and VMX3 are trademarks of Vortex Optics.

VORTEX®

TACTICAL OPTICS | THE FORCE OF OPTICS

VIP WARRANTY

OUR UNCONDITIONAL PROMISE TO YOU.



Vortex will repair or replace the product.

Absolutely free – no matter the cause.

- »» Unlimited
- »» Unconditional
- »» Lifetime Warranty

www.vortextactical.com

2120 West Greenview Drive, Middleton, WI USA 53562 • 800-426-0048